



WPH 168 / WPH 136 PORTABLE HEAT PUMP



OWNER'S MANUAL

SAVE THESE INSTRUCTIONS FOR FUTURE REFERENCE

TABLE OF CONTENTS

TABLE OF CONTENTS	2
DESCRIPTION	3
ORIGINAL INSTRUCTIONS	4
ASSEMBLY	6
INSTALLATION.....	7
OPERATION	8
MAINTENANCE	10
SELF-DIAGNOSTIC ALARM CODES	12
WIRING DIAGRAM.....	13
TROUBLESHOOTING CHART	14

DESCRIPTION

Climate Rental Solutions Portable Air Conditioners feature spot cooling for large areas where cooling of the entire area is not practical. A dedicated spot cooling thermostat controls the unit in this application. These air conditioners can also be used in smaller areas for room cooling.

A control panel provides ease of use and contains a self-diagnostic function and display, showing operating modes, room and set temperatures, and faults. If an abnormal operation occurs, a visual display of the fault is shown. Caster wheels are included for easy portability.

Suitable applications include: a factory or work place, industrial kitchen, computer room, emergency cooling, outdoor event, etc.

UNPACKING

After unpacking the unit, carefully inspect unit for any damage that may have occurred during transit. Check for any loose, missing, or damaged parts.

SPECIFICATIONS

Model	Capacity	Refrigerant	Electrical supply	Power Consumption Watts	Rated Current
WPH168	Cooling 16,800BTU (4.9Kw) Heating 18,500BTU (5.4Kw)	R410A (1.4kg)	230V, 1phase, 50hz	8.5A	Cooling 1.7Kw Heating 1.7Kw
Model	Depth / Width/ Height / Weight	Fan speeds	Air flow (high/low)	Noise level at 3m (high/low)	Operating range
WPH168	612 / 767 / 1040 (mm) / 104kg	6	470 / 200 CFM	Below 70 dBA	Cooling 18 ~ 45°C Heating 12 ~ 27°C

ORIGINAL INSTRUCTIONS

Thank you for selecting this Climate Rental Solutions Portable Heat pump. It provides you with spot cooling/heating for large areas where cooling/heating of an entire area is not practical or possible. Please read this manual before installing the WPH168 as it provides important information that should be followed during installation and maintenance of the Portable Heat pump, allowing you to correctly set up your system for the maximum safety and performance. Included is information on customer support and service, if it is required. If you experience a problem with the unit, please refer to the Troubleshooting section in this manual to correct the problem. If the problem is not corrected, please collect information so that the Technical Support personnel can more effectively assist you.

GENERAL SAFETY INFORMATION

Please read this manual carefully for instructions on correct installation and usage. Please read all safeguards.

1. Transport and store the unit in an upright position only. Leave unit in an upright position for at least 3 hours before first use.
2. Always place the unit on an even, level surface.
3. Ensure the unit is connected to a grounded power supply of the correct rating / capacity.
4. The unit will cool when the room temperature is between 18°C (64°F) ~ 45°C(113°F) and heat when the room temperature is between 12°C(54°F) ~ 27°C(80.6°F), depending on the thermostat setting.
5. DO NOT use this unit for functions other than those described in this instruction manual.
6. DO NOT tilt the unit.
7. DO NOT cover or obstruct the unit's inlet and outlet grilles.
8. DO NOT use the unit in areas where it will be exposed to rain or water.
9. NEVER unplug the unit while it is operating.



WARNING! DO NOT use the unit in wet environments, such as a laundry room, to avoid the risk of electrical shock.

10. DO NOT place any foreign objects on the unit.
11. DO NOT operate the unit with wet or damp hands.
12. DO NOT allow chemical substances to come into contact with the unit.
13. DO NOT operate the unit in the presence of flammable substances or vapors such as alcohols, pesticides, gasoline, etc.



WARNING! DO NOT operate the unit in explosive or flammable environments.

14. DO NOT use the plug to start and to stop the unit. Always use the control panel to start and to stop the unit.
15. Always turn off the unit when it is not in use and unplug the power plug from the electrical outlet.
16. Always turn the unit off and unplug the main power plug from the electrical outlet before cleaning, moving or performing maintenance.
17. AVOID the use of adapter plugs or extension cords. If it is necessary to use an extension cord or an adapter plug to operate the unit, ensure that they are correctly rated for the application. Consult a local qualified electrician and all local electrical codes to ensure proper setup. Any extension cord used with this device must be rated for a minimum of 10A.(230V)
18. DO NOT unplug the unit by pulling on the electrical cord. Keep electrical cord away from heat sources and always completely unroll the cord to avoid overheating. If the power cord becomes damaged, a qualified service agent, qualified electrician, or similarly qualified person must replace it, in order to avoid a hazard or shock.

**WARNING! DO NOT operate a unit with a damaged power cord.**

19. The filters must be used with the product at all times. When the filters are removed for cleaning, always ensure that the unit has been turned off and unplugged from the electrical outlet.
20. Regularly clean the filters to maintain efficiency. If the filters are not cleaned regularly, the units output performance and efficiency will decline and energy consumption will increase.
21. DO NOT operate the unit with a damaged power cord or plug, after it malfunctions, has been dropped or damaged.
22. Only use in the upright position on an even, flat surface. Unit must be positioned at least 24 inches (60 cm) from the nearest object in any direction.
23. Stop operation immediately if abnormal noise or odor is noticed. Contact a local service center.
24. This appliance is not intended for use by persons (including children) with reduced physical, sensory or mental capabilities, or lack of experience and knowledge, unless they have been given supervision or instruction concerning use of the appliance by a person responsible for their safety.
25. This appliance can be used by children aged from 8 years and above and persons with reduced physical, sensory or mental capabilities or lack of experience and knowledge if they have been given supervision or instruction concerning use of the appliance in a safe way and understand the hazards involved. Children shall not play with the appliance. Cleaning and user maintenance shall not be made by children without supervision.
26. The appliance shall be installed in accordance with national wiring regulations.
27. If the supply cord is damaged, it must be replaced by the manufacturer, its service agent or similarly qualified persons in order to avoid a hazard.
28. This appliance is intended to be used by expert or trained users in shops, in light industry and on farms, or for commercial use by lay persons.

ASSEMBLY

Component parts

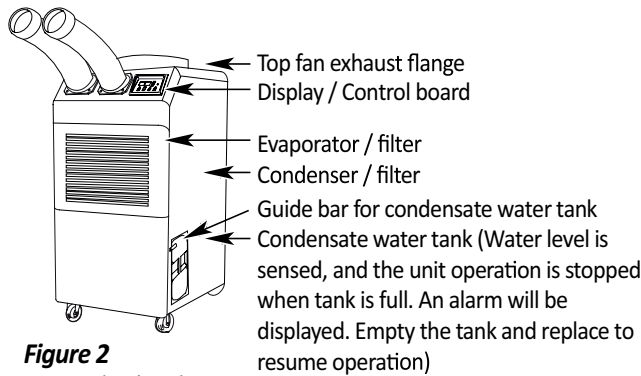

Figure 2
Front and Right Side View

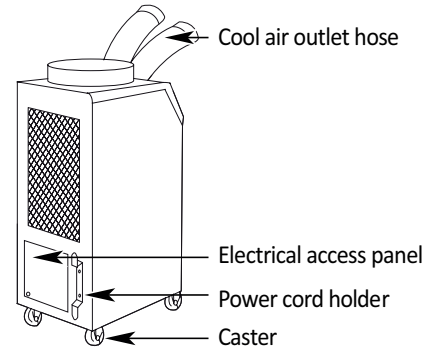
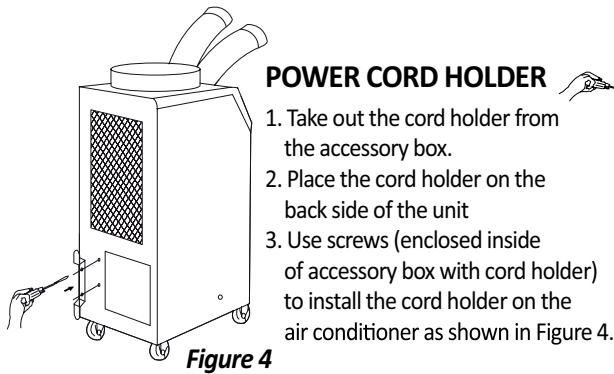

Figure 3
Back and Left Side View



POWER CORD HOLDER

1. Take out the cord holder from the accessory box.
2. Place the cord holder on the back side of the unit
3. Use screws (enclosed inside of accessory box with cord holder) to install the cord holder on the air conditioner as shown in Figure 4.

Figure 4

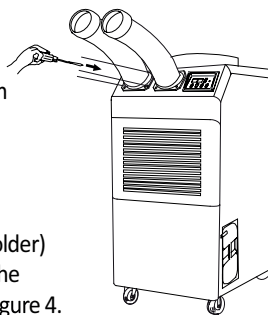

Figure 5

DISCHARGE DUCTS/SUPPLY AIR DUCT

1. Remove cool air outlet hose(s) from carton.
2. Place the cool air outlet hose(s) on the front top of the unit
3. Use screws (enclosed inside of box with cool air outlet hose(s) to install the cool air outlet hose(s) on the unit as shown in Figure 5.

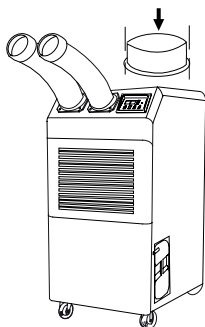

Figure 6

TOP FAN EXHAUST FLANGE

1. Remove the top fan exhaust flange from carton.
2. Place the top fan exhaust flange on the top of the unit.
3. Use screws (enclosed inside of box with the top fan exhaust flange) to install the top fan exhaust flange on the unit as shown in Figure 6.

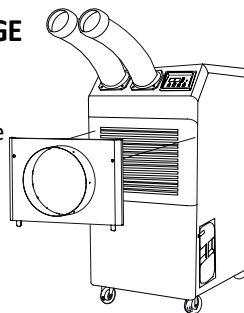

Figure 7

EVAPORATOR PLENUM (Optional)

An evaporator plenum can be purchased separately. Plenum fits over the evaporator to duct evaporator air to the unit to improve cooling efficiency.

1. Remove the evaporator cover from the unit.
2. Remove the filter from the evaporator cover and put it into the plenum.
3. Install the plenum in front of the evaporator.

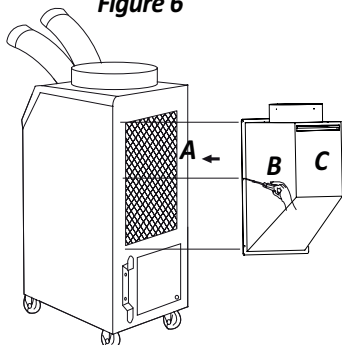

Figure 8





CONDENSER PLENUM (Optional)

Condenser plenum can be purchased separately. Condenser plenum fits over the condenser to duct condenser air to the unit to improve cooling efficiency.

1. Remove the Filter("A")
2. Check the Filter("C") is inserted properly in Condenser plenum("B")
3. Install "B" which contains "C" by using driver with enclosed bolts(6EA) as Figure 8.

INSTALLATION

WARNINGS REGARDING PROPER LOCATION FOR INSTALLATION

-  **WARNING** Do not use the unit in explosive environments or in areas where flammable gas leakage may occur.
-  **WARNING** Do not use the unit in areas where it will be exposed to rain or water.
-  **WARNING** Do not use the unit in a corrosive atmosphere.
-  **WARNING** Do not use the unit above 12°C(54°F) ~ 45°C(113°F).
-  **WARNING** Do not install the unit on uneven or sloping surface. The unit may roll or topple over even if the casters are set to the locked position.

MOVING THE UNIT

Unlock the casters and push the unit using the side handles to a flat, level surface and set the caster brakes to the locked position.

PLUGGING IN THE UNIT

Check the prongs and surface of the power cord plug for dust/dirt. If dust and/or dirt are present, wipe off with a clean, dry cloth.

Check the power cord, plug and prongs for damage or excess play. If any damage or excess play is found, contact a qualified repair technician or a qualified electrician to perform replacement or repair of the power cord, plug or prongs.

 **WARNING** If the power cord or plug is damaged, repair should only be performed by qualified electrical personnel.

 **WARNING** Do not connect / disconnect the power cord or attempt to operate buttons with wet hands. This could result in electrical shock.

NOTE: Make sure the AC outlet is free of dirt, dust, oil, water, or any other foreign material. The unit is equipped with an approved NEMA plug configuration. The appropriate outlet must be used for each plug type.

* Replaceable Fuse Rating

- FUSE 1 : 10A / 250V, 20 x 50mm, Equivalent
- FUSE 2 : 3.1A / 250V, 20 x 50mm, Equivalent

OPERATION

CONTROL PANEL

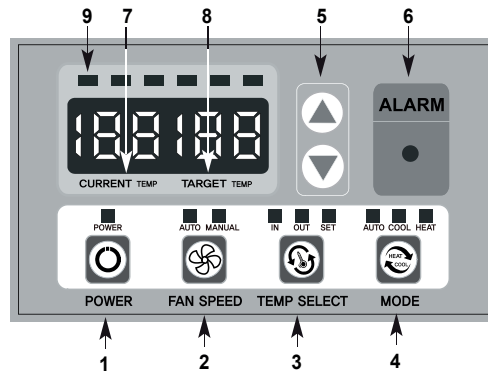

Figure 9

When power is connected POWER lamp will be on.

1. POWER BUTTON

- Activates unit when POWER BUTTON is pressed for 2 seconds. If POWER BUTTON is pressed for 2 seconds during operation, unit stops.

NOTE : It will take more than 10 seconds to start fans.

2. FAN SPEED BUTTON

- Changes fan speed from (AUTO) to (MANUAL) when pressed.
- When MANUAL lamp is on, change fan speed between 1 and 6 step by pressing UP/DOWN BUTTONS.
- When AUTO lamp is on, fan speed is changed automatically between 1 and 6 step. When COOL mode, fan speed starts in high speed. When HEAT mode, fan speed starts in low speed.

3. TEMP SELECT BUTTON

- Choose temperature sensor by pressing this button shortly.
- When IN lamp is on, inlet temperature sensor works so it is used to control inside of a room.
- When OUT lamp is on, outlet temperature sensor works so it is used to provide cool air or hot air directly to people or material.
- By pressing this button for 2 seconds, SET lamp will be on and SET mode activates. Then set the target temperature by pressing UP/DOWN BUTTONS. After setting the target temperature, press TEMP SELECT BUTTON for 2 seconds and SET lamp will be off and setting temperature will be memorized.

4. MODE

- Choose cooling, heating or auto by pressing this button. When all lamps are off, it is blower mode so only fan operates without operating compressor.
- When AUTO lamp is on, it activates cooling or heating automatically according to TARGET TEMP. It activates cooling when TARGET TEMP is lower than CURRENT TEMP and will change to activate heating when CURRENT TEMP reach over the TARGET TEMP by 6°F(3°C) and change to activate cooling when CURRENT TEMP reach over the TARGET TEMP by 6°F(3°C).

5. UP/DOWN BUTTONS

- Change TARGET TEMP value by +/-1.

6. ALARM

- ALARM indicator lights (blinks) and indicates abnormal system operation. If ALARM occurs, compressor stops. System operation stops when ALARM light is activated (blinks) longer than 3 minutes.

7. CURRENT TEMP

- When IN lamp is on in TEMP SELECT, it displays current room temperature.
- When OUT lamp is on in TEMP SELECT, it displays outlet (cool/hot air) temperature.
- Initial unit is °F. In order to change from °F to °C, press POWER BUTTON and MODE BUTTON together for 2 seconds. Choose 7 by pressing UP/DOWN BUTTON. Choose 0 by pressing UP/DOWN BUTTON. Press MODE BUTTON for 2 seconds then figure will change to °C

8. TARGET TEMP

- Displays the unit set temperature.
- When OUT lamp is on in TEMP SELECT, always set TARGET TEMP value 32°F (0°C) for COOL mode and 122°F (50°C) for HEAT mode.
- When IN lamp is on in TEMP SELECT, recommendable TARGET TEMP is between 64°F and 113°F (18°C and 45°C) for both COOL mode and HEAT mode. Recommendable TARGET TEMP for Auto mode is between 70°F and 113°F (21°C and 45°C)

9. EVA FAN STEP

- Lamp(s) is(are) on according to eva fan speed. 1 lamp is on when 1 step and 2 lamps are on when 2 step ... 6 lamps are on when 6 step.

OFF TIMER

- Enter to timer setting mode by pressing FAN SPEED BUTTON and TEMP SELECT BUTTON together for 2 seconds.
- Press UP/DOWN BUTTON to set the timer until it shows the figure you want to set. Setting range is between 30 minutes and 12 hours.
- If you press MODE BUTTON for 2 seconds, the figure will be memorized and the compressor will stop after the time set.
- Display will show CURRENT TEMP (for 5 seconds) and remaining time (for 2 seconds) in turn repeatedly.

AUTO RESTART

- If the unit goes off due to an electrical interruption, the unit will automatically restart when the power resume.

MAINTENANCE

FILTER CLEANING (See Figures 10 and 11)

There are two filters in the unit. The evaporator filter is located at the front of the unit. The condenser filter is located at the back of the unit.

1. Pull the filter frame forward to remove the front filter.
2. Slide filter up and use a vacuum cleaner to remove the dust from the filter.
3. If the filter is heavily covered with dust and dirt, warm water and mild soap or neutral detergent may be used to wash the filter. Do not use any other chemicals to clean filter, as they will likely damage the filter.
4. Dry the filter in a shaded area before replacing it. Do not operate the unit without the filter installed and the filter guard in the closed position.
5. Replace the clean filter and close the filter guard.
6. To clean the condenser filter, lift up on the rear filter from the middle bar slightly and then angle the filter outwards from the bottom and remove.
7. Use the same cleaning procedure as above (3 – 5).
8. To replace the condenser filter, place the top of the filter in the guide and slide the filter up until the bottom of the filter clears the frame. Then push the bottom of filter into the guide and let filter gently fall inside the guide.

NOTE: For effective cooling clean the filter at least every 2 weeks.

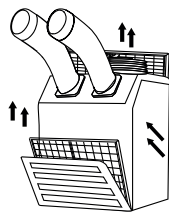

Figure 10 – Removing Filters

- Pull the filter frame forward to remove the front filter
- Slide filter up and use a vacuum cleaner to remove the dust from the filter.

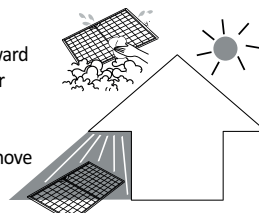

Figure 11 – Removal of Dust

- Remove dust from the filter using a vacuum cleaner hose attachment.
- If required wash the filter in lukewarm water with a mild detergent. Leave to dry in a shaded area before reinstalling.



WARNING Do not operate without the filter fitted.



WARNING Do not operate the unit with a damaged cord or plug, after the unit malfunctions, or if the unit has been dropped or damaged.

- For your convenience, record the complete model number and product name (located on the Product Identification Plate), the purchase date, purchase location, serial number, and warranty period in the table below.
- Also, attach your purchase receipt as proof of purchase to this instruction manual for future reference.
- To ensure your product is covered by warranty, the complete faulty product along with your original purchase receipt must be provided at the place of purchase.
- To ensure your product is covered by warranty, the complete faulty product along with your original purchase receipt must be provided at the place of purchase.

Product	Portable Air Conditioner
Model No.	_____
Date of Purchase	_____
Place of Purchase	_____
Serial No.	_____
Period of Warranty	_____

Customer: Please read and keep this manual for future reference and keep sales receipt as proof of purchase.

SPRING REPLACEMENT (See Figure 12)

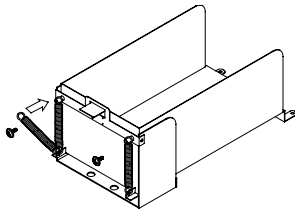













Figure 12 – The process of spring replacement

- There are two springs on the rear of condensate water tank guide.
1. Release the screw on the spring hook.
 2. Take off the spring hook, and then pull out the opposite spring hook from hole in the condensate water tank guide.
 3. Replace with a new spring in reverse order.
 4. Repeat this cycle for the other spring.

SELF-DIAGNOSTIC CODES (See Table 1)

The alarm light is activated if abnormal operation occurs, and a code is displayed on the control panel. The compressor and condenser fan motor will stop operating. The evaporator fan will continue to run for 3 minutes. If the fault is rectified within 3 minutes, the unit will resume operation. If the fault persists for more than 3 minutes, the evaporator fan also stops. The fault must be rectified before the unit can resume normal operation.

SELF-DIAGNOSTIC ALARM CODES

Alarm Display	Problem	Cause	Corrective Action
	Low pressure sensor works	<ul style="list-style-type: none"> Coolant leakage Low pressure sensor has a loose or broken connection 	Contact a qualified service agent
	Frost prevention sensor and Abnormal temperature sensor value	<ul style="list-style-type: none"> Indoor heat exchanger temperature is too low Eva filter is blocked Low pressure sensor has a loose or broken connection 	<ul style="list-style-type: none"> Do not use the air conditioner if ambient temperature is lower than 64°F(18°C) Clean the Eva filter Contact a qualified service agent
	High pressure sensor works	<ul style="list-style-type: none"> Cond filter is blocked Exhaust duct is blocked or kinked Ambient temperature is too high High pressure sensor has a loose or broken connection 	<ul style="list-style-type: none"> Clean the Cond filter Ensure exhaust duct is not blocked/kinked Do not use the air conditioner if ambient temperature is higher than 113°F(45°C) Contact a qualified service agent
	High pressure sensor works	<ul style="list-style-type: none"> Ambient temperature is too high Cond filter is blocked 	<ul style="list-style-type: none"> Do not use this product if ambient temperature is higher than 113°F(45°C) when cooling, 77°F(25°C) when heating Clean the Cond filter
	Abnormal temperature sensor value	Outlet temperature sensor has a loose or broken connection	Contact a qualified service agent
	Abnormal temperature sensor value	Inlet temperature sensor has a loose or broken connection	Contact a qualified service agent
	Compressor overloaded	<ul style="list-style-type: none"> Ambient temperature is too high Unstable voltage supply Defective compressor 	<ul style="list-style-type: none"> Do not use the air conditioner if ambient temperature is higher than 113°F(45°C) Contact a qualified service agent Replace compressor
	Condenser fan alarm	Voltage of condenser fan is lower than normal. Condenser fan is failure.	Contact a qualified service agent
	Evaporator fan alarm	Voltage of evaporator fan is lower than normal. Evaporator fan is failure.	Contact a qualified service agent
	Drain pump alarm	Drain pump defective or improper hose connection (including kink or blockage)	<ul style="list-style-type: none"> Check the hose connection and hose Replace drain pump After corrective action, press the UP/DOWN buttons together for 2 seconds to resume operation
	Condensate water level alarm	Condensate tank is full	<ul style="list-style-type: none"> Empty the water tank After installation of the water tank, press the UP/DOWN buttons together for 2 seconds to resume operation

*The unit operates without stop even though FC alarm occurs.

Table 1- Alarm Codes

WIRING DIAGRAM

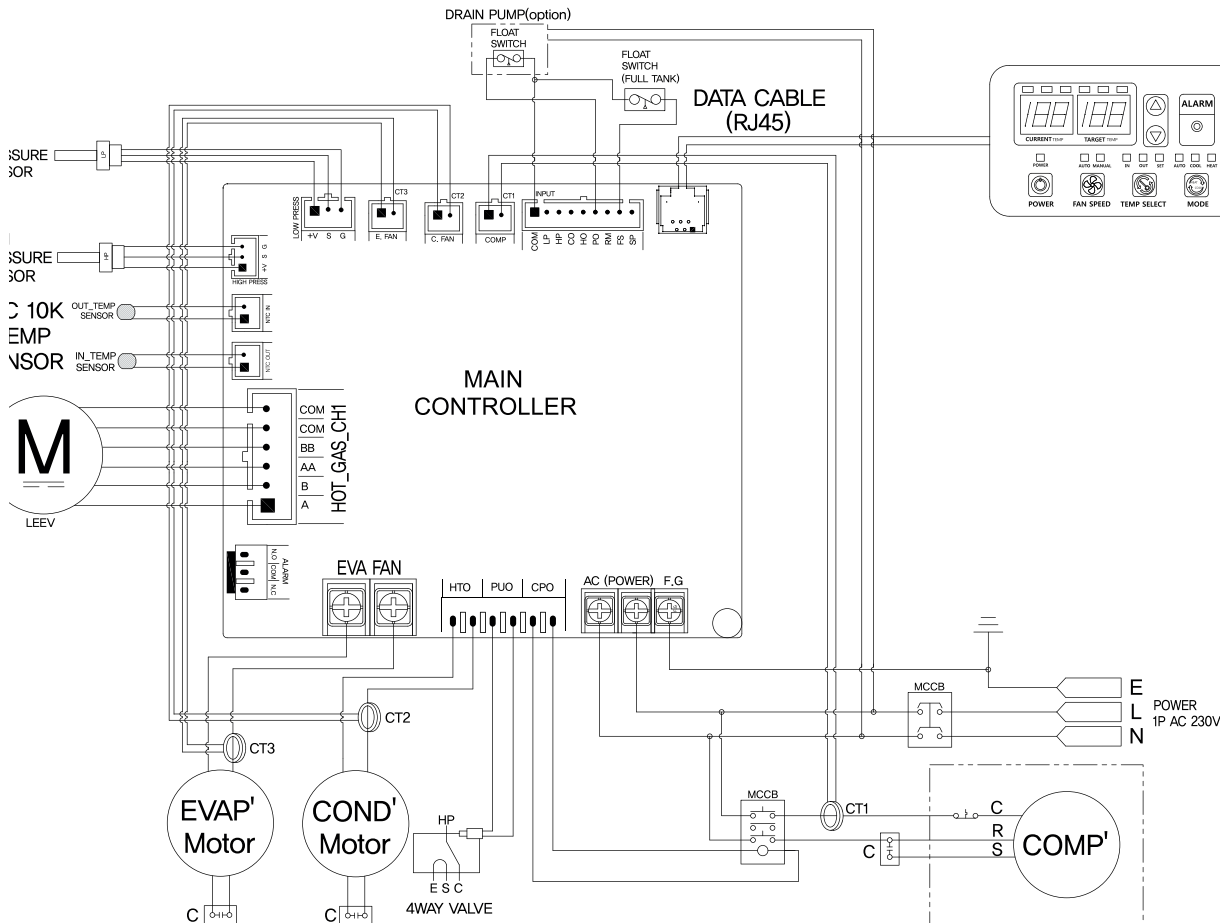

OBTAINING SERVICE

If the Climate Rental Solutions Portable Air Conditioner requires Service:

1. Use the TROUBLESHOOTING section in this manual to eliminate obvious causes.
2. Verify there are no circuit breakers tripped.
3. Call your dealer for assistance. If you cannot reach your dealer, or if they cannot resolve the problem, call Climate Rental Solutions Portable Air Conditioner Technical Support at 1300.447.247 Please have the following information available BEFORE calling the Technical Support Department:
 - a. Your name and address.
 - b. The serial number of the unit.
 - c. Where and when the unit was purchased.
 - d. All of the model information about your Climate Rental Solutions Portable Air Conditioner.
 - e. Any information on the failure, including LED's that may or may not be illuminated.
 - f. A description of the protected equipment, including model numbers if possible.

TROUBLESHOOTING CHART

SYMPTOM	POSSIBLE CAUSE(S)	CORRECTIVE ACTION
Water leakage	High water level in condensate tank	<ol style="list-style-type: none"> 1. Remove blockage from drain hose 2. Remove any object stuck underneath of the black panel under the water tank
The unit doesn't work	<ol style="list-style-type: none"> 1. Check the power supply to verify that power is available to the unit 2. Verify that the power cord is connected 	<ol style="list-style-type: none"> 1. Reset the circuit breaker and restart the unit 2. Connect power cord 3. Wait for 20 seconds
No cold air flows from the cold air outlet	<ol style="list-style-type: none"> 1. Ambient air cannot be properly cooled if the filter is dirty and not regularly cleaned 2. Compressor will not work if the unit is turned off and on quickly. 3. The ambient air temperature may be too high 	<ol style="list-style-type: none"> 1. Clean the filter 2. Wait 2 minutes after unit is turned off before turning the unit back on. 3. The temperature of the compressor can be higher when the ambient temperature is too high. The compressor will not work unless the ambient air temperature is within the acceptable operating range of the unit
Water flow can be heard after compressor shuts off	No cause	Common to hear coolant flowing after unit shuts off
Alarm displays "FT" with less than half of condensate water in the tank Spring is possibly broken	Spring is possibly broken	Replace a new spring (See Maintenance page 10)