



PA 28 AND PA 45 PACKAGED UNIT



INSTRUCTION MANUAL

SAVE THESE INSTRUCTIONS FOR FUTURE REFERENCE

TABLE OF CONTENTS

FOREWORD	3
INTRODUCTION	3
EQUIPMENT INSTALLATION	4
OPERATION CONSIDERATIONS	6
MAINTENANCE CONSIDERATIONS.....	7
ELECTRIC OPERATION	7
FAILURE INPUT AND PROTECTION ALARMING.....	12
MAINTENANCE	13
COMMUNICATION PROTOCOL	13

FOREWORD

Thank you for choosing us. Please read the manual carefully before you install and use our products. We preserve the rights to change the contents of this manual. We shall not be responsible for the loss and failure caused in the process of installation due to not conforming to this manual.

INTRODUCTION

Rooftop Packaged Unit series include 12 optional models. Everyone has been through wide market research and long time actual operation in system, structure and control, ensuring that every model can be designed on the basis of best price.

The series of units are applied in the industrial and commercial fields such as hotel, supermarkets, authorized dealing shop, office building and factory workshop. They perfectly connect many characteristic of large-sized central a/c, such as convenience, comfort, high-grade and the simplicity and flexibility of split units. The new design makes use of the space module, the features of small-sized commercial modern building space, making the cool and heat air spread into every room averagely to form "Zero" temperature difference. Besides, outdoor fresh air can be absorbed.

The air path can connect with indoor ornament which is completely hidden and doesn't occupy any space. It has become a new generation of products of central a/c and traditional commercial a/c.

CHARACTERISTIC AND MERITS

- 1. Various products and wide application**
The series of Rooftop packaged units include many different specifications which can completely meet the demand of home and commercial places' requirement and offer you a comfortable and pleasant environment.
- 2. Complete air system, simple and hygiene, less components, easy maintenance**
The flexible and concise design makes the maintenance very simple. Disassembling several bolts from any side of the unit can repair any part of the unit.
- 3. Intelligent controller**
Microcomputer intelligent controller can reach four control modes : cooling, dehumidifying, and ventilation. It also has the functions of timing on-off and failure display.
- 4. Excellent performance**
World well-known brand of main parts are used. To guarantee the rational match of the unit, strict performance testing is done. Besides the unit runs steady and the vibration and noise are effectively controlled by the use of multi-vane pitch centrifugal fan, world-known high efficiency compressor and the elaborative-designed controller, motor, etc.
- 5. Quiet operation and convenient maintenance**
Reach the lowest noise of the a/c room. The a/c units are placed far from the a/c area which meets the demand of indoor low noise to the greatest degree. The adoption of high efficiency and low noise centrifugal fan makes the quiet operation come true.

EQUIPMENT INSTALLATION

INSTALLATION NOTICE

The equipment installation must be completed by professionals. Installation by non-professional staff may lead to improper operation, even failure. Take necessary protection to the unit when moving the units. It is not allowed to make forcible operation to damage the units.

UNIT INSTALLATION

1. The installation location should make the hot air through condenser not to be absorbed back to the unit or absorb hot air which comes from another unit. Besides, enough space should be kept for unit maintenance.
2. Barrier should not exist to block the air discharge and air suction in the passage of air discharge and air suction of the units.
3. There should be good ventilation at the location of unit installation so as to take away the heat air blown from the unit and bring in the air at a lower temperature.
4. The unit should be installed on a base which is firm and flat, 50~100mm higher than the plane. Enough strength should be kept to support the weight of the unit and the vibration when running.
5. The unit should be installed horizontally to decrease the vibration, lower the noise and make the condensing water discharge smooth. The condensing water discharge vent of the unit must have water seal whose height should be more than 50mm.
6. Keep the installation away from the dirty or oily place so as not to block the heat ex-changer.
7. Following space is suggested during installation.

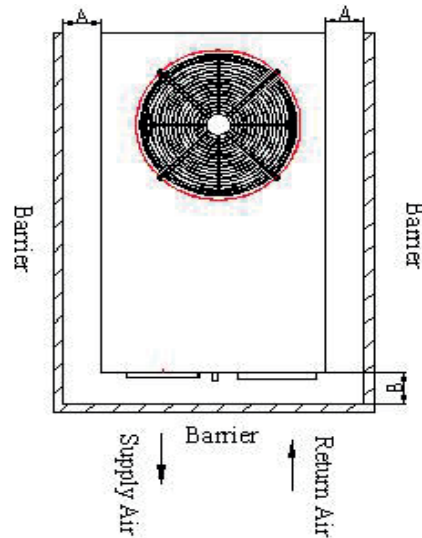
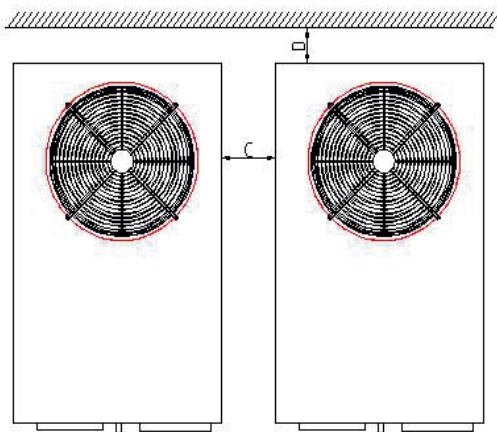

No.	18	21	28	36	50	62	72	88	105	140	175	210
A	500	1200	1200	1600	1600	2000	2000	2500	2500	2500	2500	2500
B	500	500	500	500	500	800	800	1200	1200	1200	1200	1200
C	500	2000	2000	2000	2000	2000	2000	2500	2500	2500	2500	2500
D	300	1200	1200	1600	1600	2000	2000	2500	2500	2500	2500	2500

DUCT INSTALLATION

1. Usually two air supply ducts: Rectangle air duct and circular one.
2. Rectangle air duct can connect the air supply inlet of the indoor unit by flexible connection.
3. For circular duct, add a transition duct to the air inlet of indoor unit, and be connected separately to air diffuser, (referring to the drawing),the air inlet velocity of air diffuser should be the same to meet the requirement.
4. Suggest using silencer box in the air supply duct of the heavy airflow unit to lower noise.
5. If adopting fresh air, the fresh air entrance is better to choose the place where the air is clean and there is no pollution. As for the outdoor air entrance, rain-proof shutter and filter should be installed and at the fresh air section, air flow adjuster should be installed. It is suitable when the fresh air quantity makes up 10% of the total air quantity.

Model	Name
1	Main pipe
2	Branch pipe
3	Air supply pipe

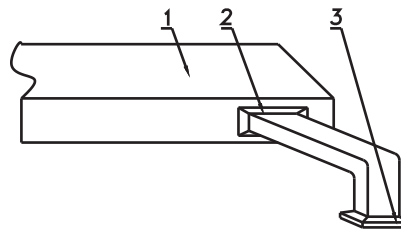

AIR DUCT HEAT PRESERVATION

Air supply and air return pipes should both have heat preservation. First of all, stick the nail on the air duct and then attach the cotton preservation with tin foil paper. Fasten it with nails and seal the connection with tin foil adhesive tape.

Model	Name
1	Galvanized plate
2	Nail
3	Cotton preservation
4	Tin foil
5	Nail cover
6	Adhesive tape

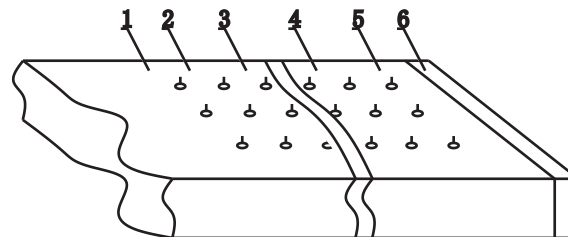

Remarks:

- Every air supply pipe and return air pipe should have iron bracket fastened on the floor prefabricated board. The air duct connector should be sealed tight by adhesive tape.
- It is recommended that the air return margin should keep the wall 150mm far.

ELECTRIC APPLIANCE INSTALLATION

1. The power supply capacity must meet the a/c requirement. The voltage at the side of the power supply incoming line inside the a/c unit should remain within +10% rating and the power supply frequency is within 2%.
2. Cut the power supply at electric wire connection. Forbidden to operate with electricity.
3. To protect the staff and avoid the danger of electric shock caused by leakage, the unit body should have good and reliable grounding protection setting to prevent the electric shock accident. It also needs check the ground-

- ing line very often to guarantee a good grounding(grounding resistance should not exceed 4 ohm)
4. The layout of power supply routing must conform to the national standard and the unit body must have good grounding to avoid the danger caused by insulation failure. The indoor suspending routing adopts electric specialized PVC conduit tube and PVC connection wire box with cover (not use recycling material connection wire box) Wiring conduit should flat and erect and be fixed. Threading pipe should not use right angle elbow plumbing, but use proper siphon spring bend. The radius of the syphon should be more than four times as long as the diameter of the conduit. Drape should not occur after bending the threading pipe. Lay the connection box properly so as to easy maintenance and wire changeover.
 5. The communication wire (Temp. Probe connection wire) and the power supply source should be laid separately to prevent interruption.

OPERATION AND COMMISSIONING

1. Inspection before operation Read the wiring diagram and make sure that wiring and communication wiring are correct and meet requirements. Make sure that the unit has ground wire protection.
2. First Time Operation

After a complete inspection of the whole system, a trial operation can be conducted.

- Connect the power and watch the thermostat. If the wiring controller does not display “search the power”, the unit cannot start until wiring controller displays normally.
- Listen carefully if there is any strange sound of the unit, or if the compressor or fan operates normally. Disconnect power to check the unit if there is strange sound.
- Examine the temperature of each room to see if the temperature changes are normal. Modify the air valves of duct of each room to meet airflow volume requirement of each room. Set the work condition and then examine it to meet the requirement.
- Keep trial operating for some time (about 3 days).

OPERATION CONSIDERATIONS

INSPECTION BEFORE OPERATION

1. Read the wiring diagram and nameplate, make sure that wiring and power are correct and meet requirements, otherwise not operate.
2. Inspect the connection of wires are enough firm. Make sure that the unit has good ground wire protection.
3. The power supply capacity must meet the a/c requirement. The voltage at the side of the power supply incoming line inside the a/c unit should remain within +10% rating and the power supply frequency is within 2%.
4. Make sure that the 3 phase of main power supply is correct. Cut the power supply at electric wire connection. Forbidden to operate with electricity.
5. Make sure that the setting data of controller are correct.
6. Not operate or cut any valves arbitrarily.
7. The communication wire (Temp. Probe connection wire) and the power supply source should be laid separately to prevent interruption
8. The installation location should be clean, dry and make the hot air through condenser not to be absorbed back to the unit or absorb hot air which comes from another unit. Besides, enough space should be kept for unit maintenance.
9. The unit should be installed horizontally to decrease the vibration, lower the noise and make the condensing water discharge smooth. The condensing water discharge vent of the unit must have water seal whose height should be more than 50mm.
10. Check the filter and make sure it is not blocked.

FIRST TIME OPERATION

After a complete inspection of the whole system, a trial operation can be conducted.

1. Connect the power and watch the thermostat. If the wiring controller does not display, the unit cannot start until wiring controller displays normally.
2. Listen carefully if there is any strange sound of the unit, or if the compressor or fan operates normally. Disconnect power to check the unit if there is strange sound.
3. Examine the temperature of each room to see if the temperature changes are normal. Modify the air valves of duct of each room to meet airflow volume requirement of each room. Set the work condition and then examine it to meet the requirement.
4. Keep trial operating for some time (about three days).

MAINTENANCE CONSIDERATIONS

1. The on-off of the unit per hour should not exceed four times, otherwise the service life of the unit will decrease.
2. The surroundings of the units should keep clean and tidy. Clean the leaves and rubbish absorbed by the fin on time.
3. Clean the air return filter once three months to guarantee the quality of the air.
4. Check if the condensing water pipe is smooth regularly. Make sure the drainage is clear.
5. Not allowed to reset the unit by force without any reason of the trouble if something is wrong with the unit. Contact the agent or the technician.
6. All diameters have been setup at the ex-work of the units. If the customer needs to adjust the diameter, please contact the agent and the technician. It is not allowed to adjust the diameter automatically.







ELECTRIC OPERATION

OPERATION INSTRUCTION







1. Interface introduction



2. Symbol introduction.

Symbol	Meaning	Symbol	Meaning
	Supply air mode		Power on
	Cooling		Time
	Heating		Failure warning

3. Button introduction

Symbol	Meaning	Specification
	HOME	<ol style="list-style-type: none"> At checking or setting interface, press it and back to main interface; When setting parameter, press it and cancel setting; Press it for long time and display the info of the main version;
	UP	<ol style="list-style-type: none"> In main interface, press it and increase the setting temp, quickly increase the setting parameter by pressing it for long time; Any interface, if “▲” display, press it and enter last page; In parameter setting, press it and increase the parameter, quickly increase the parameter by pressing it for long time;
	DOWN	<ol style="list-style-type: none"> In main interface, press it and decrease the setting temp, quickly decrease the parameter by pressing it for long time; Any interface, if “0” display, press it and enter next page; In parameter setting, press it and decrease the parameter, quickly decrease the parameter by pressing it for long time;
	ENT	<ol style="list-style-type: none"> In main interface, press it to reset the failure have removed; When setting parameter, press it confirm the setting and turn to next parameter setting; In main interface press “ENT”“SET” for long time and enter password interface, input the passwords and enter factory setting interface; In factory parameter setting interface, press it and enter relevant setting interface;
	SET	<ol style="list-style-type: none"> In main interface, press it and enter user setting interface; In setting interface, press it and enter setting status; if no parameter need to be set, no action. In main interface, press “ENT”“SET” for long time and enter password interface, input the passwords and enter factory setting interface; In factory parameter setting interface, press it and enter relevant setting interface;
	ALARM	<ol style="list-style-type: none"> In main interface, press it and enter failure checking interface;
	POWER	<ol style="list-style-type: none"> Any interface, press it to power on/off unit;

2. Display NAV map

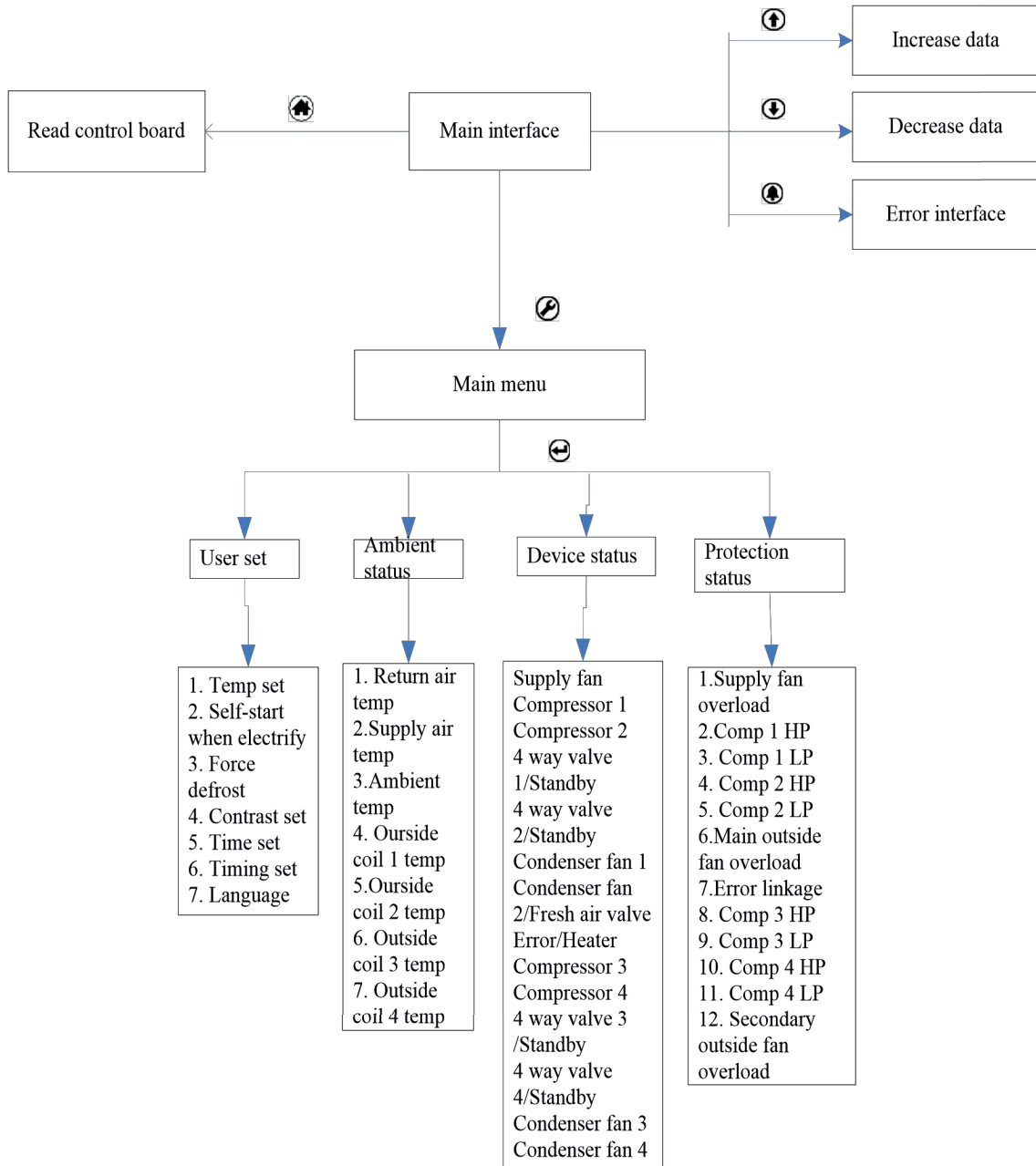

3. Electrify display

The welcome page will display for 10 sec, it display the unit information and the version of the display, press any key to cancel and enter main interface.

Welcome to use SL1500-PU2-V2.0 Rooftop unit control

4. Main interface

Turn to main interface after electrify for 10 sec, as below picture:





☼ 26.0 °C 12:00 SET:25.0 °C

*The first line show the working status: ☼ is Supply air, ❄️ is Cooling, ☀️ is Heating, means unit  is working,  is Failure;



*The second line is temperature;

*The third line show the time and setting temp, press “↑” “↓” can adjust the setting parameter at this interface, press “←” confirm the adjustment. If no, press “←” and waiting for 5 sec, system will confirm the setting.

5. Power on/off

In main interface, press “” enter operating status, top right corner display “”, mode symbol display on top line; when unit is working, in main interface press “” to shut off the unit, “” disappear.

6. User parameter setting

In main interface press “” enter “Main Menu” interface, press “” enter setting status, press “←” enter the relevant interface, if press “”, no action and turn to next function interface, “Main Menu” is as below:

Menu	
User set	ENT
Ambient state	ENT
Device state	ENT
Protect state	ENT

In setting status, press “” to adjust the value, press “↑” “↓” to turn the page; for value setting, press “↑” “↓” to change the value, user can quickly change the value by press “↑” “↓” for long time. Press “←” after setting.

Confirm the adjustment. After finish all of the setting, press “” back to Main interface. User setting is as below:

Item	Value	Unit	Default	Remark
Temp set	5.0~50.0	°C	25.0	Set the temperature
Self-start when electrify	Off/On	--	Off	Self-start when electrify
Force defrost	Off/On	--	Off	Not consider the time interval, force enter the defrost
Contrast set	20~50	--	32	Set the contrast
Time set	--	--	--	Set the time
Timing set	--	--	--	--
Language	Chinese	--	Chinese	--

7. Check the input and output

In“Main Menu” interface, user can enter the relevant interface to check the ambient status, device status and failure protection status as below:

Ambient state	
Return T.	-12.3°C
Supply T.	-12.3°C
Ambient T.	-12.3°C [~]

Menu	
User set	ENT
Ambient state	ENT
Device state	ENT
Protect state	ENT

Device state	
Air blower	<input type="radio"/>
Compr. 1	<input type="radio"/>
Compr. 2	<input type="radio"/>
4-way VLV1	<input type="radio"/> [~]

Protection state	
Blower overload	<input type="radio"/>
Compr. 1 PH	<input type="radio"/>
Compr. 1 PL	<input type="radio"/>
Compr. 2 PH	<input type="radio"/> [~]

When the status checking, press “” back to last menu, press “” for long time back to main interface.

8. Time set

In“User setting”interface, enter “Time set” interface; The first line show the time, press “” move the cursor, press “” “” to change the value.

9. Timing set

In “User setting” interface, enter “Timing set” interface. Press “” enter setting interface, press “” to select the timing date and timing on/off, press “” “” to change the value; press “” to select the setting parameter: Date → Timing on, hour set → Timing on, minute set → Timing off, hour set → Timing off, minute set; when set the power on date, the date will flicker, press “” to active the date, press “” to cancel setting; when set the time, press “” “” to adjust the value; press “” to confirm the setting, press “” back to last menu.

If the time set is 00:00, it means not activate the timing function.

10. Failure cascading

Input point of failure cascading, in order to detect external alarm signal, such as fire and so on.

FAILURE INPUT AND PROTECTION ALARMING

FAILURE LIST

All ports are normally closed according system set, if the port makes a loop with COM(Public port) of the relevant socket, it means ok; or it means failure. If you need to shield this switch input fault, only need to short of jumpers of the corresponding failure ports. System will display the error code when error happen. (*means the parameter can be set).

Failure	Condition	Delay	Duration	Corresponding action	Reset	Remark
Supply fan error Blower overload	Any time	0 sec	2 sec	Shut off unit	Manual	If error exist before unit turn on, fail to turn on, alarm alarming and display error;
HP protection	Any time	0 sec	2 sec	Shut off corresponding comp	Manual	If error exist before unit turn on, fail to start comp, alarming and display error;
LP protection	When comp start	*120 sec	2 sec	Shut off corresponding comp	Manual	Delay check after comp turn on, alarming and display error;
Condenser Fan overload	Any time	0 sec	2 sec	Shut off all comp	Manual	If error exist before unit turn on, fail to start comp, alarming and display error;
Supply T.High	When system start	0 sec	2 sec	Shut off all E-heater	Auto	Check when heating, if temp diff between inlet and outlet is 3°C, reset
Supply T.low	When system start	0 sec	2 sec	Shut off all comp	Auto	Check when cooling, if temp diff between inlet and outlet is 3°C, reset, comp restart 10 min delay.
Insuff heat	When start heating	0 sec	10 min	Shut off unit	Auto / Manual	Check when heating,keep the set temp of supply air for 10 min, protect turn off, reset if temp diff between inlet and outlet, or manual recovery.
Return T. sensor	Any time	0 sec	2 sec	Shut off unit	Auto	After reset
Supply T. sensor	Any time	0 sec	2 sec	Alarming	Auto	No action
Ambient T. sensor	Any time	0 sec	2 sec	Alarming	Auto	If error happen, not considering temp diff when defrost, not considering start logic when heating;
Fin sensor	Any time	0 sec	2 sec	Alarming, condenser fan turn to compressor link control	Auto	

FAILURE CHECKING

The failure will display automatically when failure happen. User can check the unreset error info by pressing “” in main interface.

RESET FAILURE

1. Press “” to reset the failures when the unit is working;
2. All of the failure can be reset by power off.



Before reset the failure, pls confirm the external failure is removed. Or failure can't be reset.

MAINTENANCE

1. The on-off of the unit per hour should not exceed four times, otherwise the service life of the unit will decrease.
2. The surroundings of the units should keep clean and tidy. Clean the leaves and rubbish absorbed by the fin on time.
3. Clean the air return filter once three months to guarantee the quality of the air.
4. Check if the condensing water pipe is smooth regularly. Make sure the drainage is clear.
5. Not allowed to reset the unit by force without any reason of the trouble if something is wrong with the unit. Contact the agent or the technician.
6. All diameters have been setup at the ex-work of the units. If the customer needs to adjust the diameter, please contact the agent and the technician. It is not allowed to adjust the diameter automatically.

COMMUNICATION PROTOCOL

BASIC PARAMETER

Communication band rate: 9600

Data bits: 8

Stop bits: 1

Check bit: None

Temperature and humidity deal value: Real value 10:1

Relay output: 0=OFF 1=ON

Failure input: 1=Failure 0=Normal

Figure input: 1=Abnormal 0=Normal

NO&NC 0=NC 1=NO

Default ID is “1”

Communication protocol: MODBUS-RTU

INSTRUCTIONS OF 485 SERIAL PORTS EXPANSION COMMUNICATION

Overview

This serial ports expansion board is specifically designed for our company. Usually it can only be used with our control panel. Through it, a 485 serial port can be expanded into two 485 serial ports, realizing a serial port's board connects two communicators or a monitor and a communicator simultaneously, etc.

Wiring connection

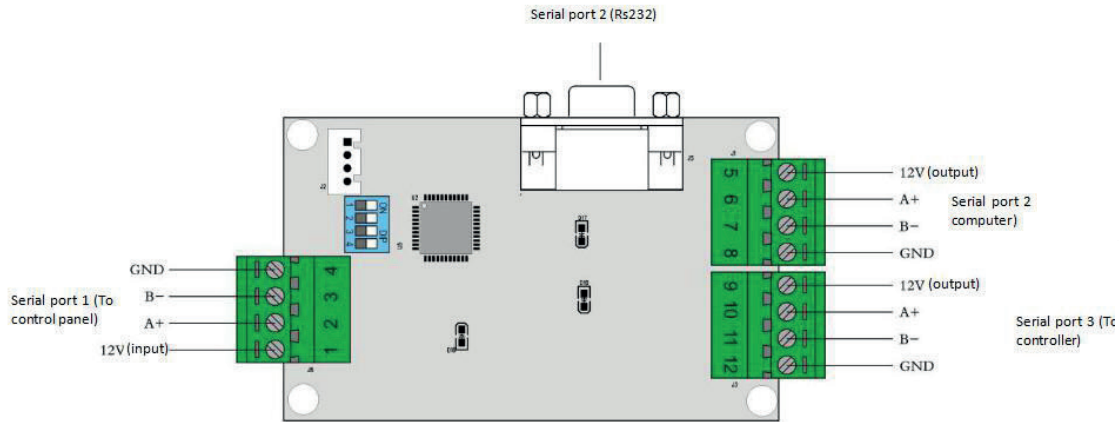

- D16: serial port 1 indicator, flashing when communicating;
- D17: serial port 2 indicator, flashing when communicating;
- D18: serial port 3 indicator, flashing when communicating;
- 12V GND of serial port 1 is power supply of control panel, with anti-reverse function;
- 12V GND of serial port 2 and 3 are output of 12V GND of serial port 1, with anti-reverse function.

Wiring principle

Serial port 1 connects with control panel and address is fixed at 1;
 Serial port 3 connects with screen and address is fixed at 1; via serial port 3, set network address of serial port 2;
 Serial port 2 connects with monitor.

Network address setting

1. DIP setting

When network address is set at 1 -15, network address can be set via DIP of control panel.

Network address	DIP1	DIP2	DIP3	DIP4
1	ON	OFF	OFF	OFF
2	OFF	ON	OFF	OFF
3	ON	ON	OFF	OFF
4	OFF	OFF	ON	OFF
5	ON	OFF	ON	OFF
6	OFF	ON	ON	OFF
7	ON	ON	ON	OFF
8	OFF	OFF	OFF	OFF
9	ON	OFF	OFF	ON
10	OFF	ON	OFF	ON
11	ON	ON	OFF	ON
12	OFF	OFF	ON	ON
13	ON	OFF	ON	ON
14	OFF	ON	ON	ON
15	ON	ON	ON	ON

2. Software setting

SL485 serial port expansion board can also set network address of serial port 2 through software. At this point, all DIP must be in the "OFF" state. Its wiring connection is as follows :

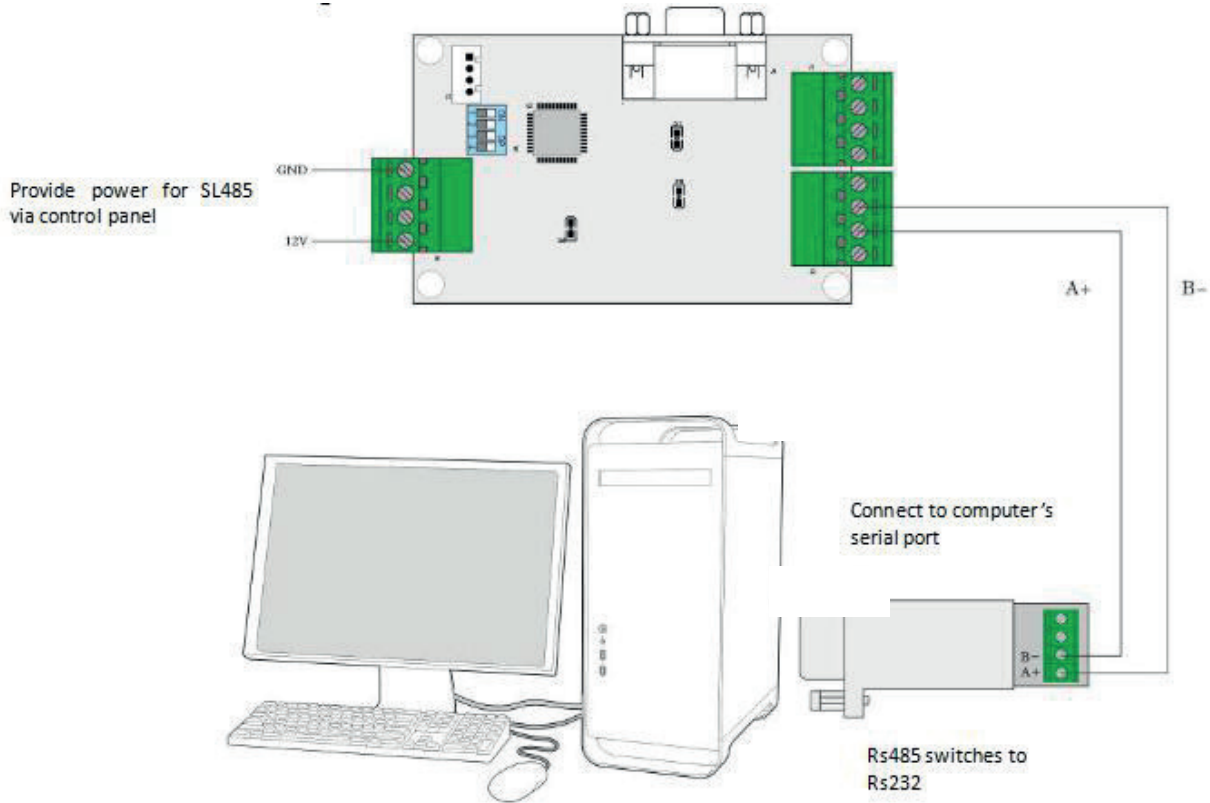

Electrify SL485 serial port expansion board and double-click “” icon to open address setting software, as shown below:

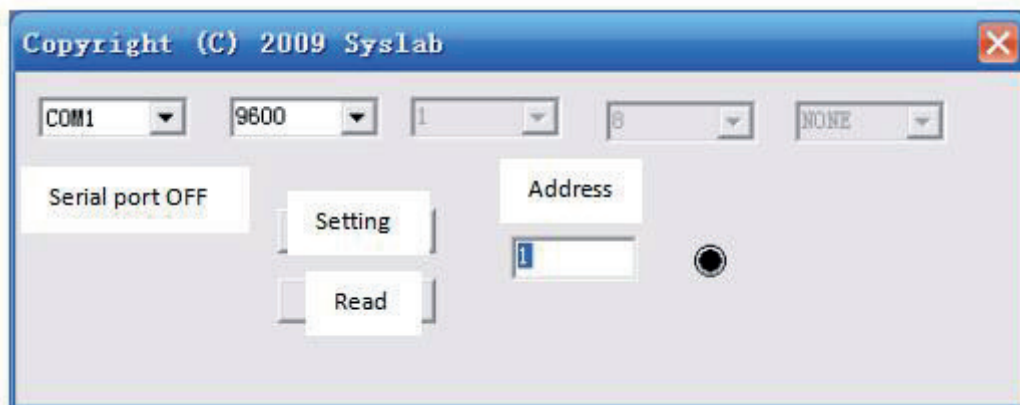

If the computer's serial port number is not COM1, set it to the corresponding port number; fill network address number you want to set in the address bar and press the "Setting" button; if the indicator flashes once (red), it means the address is set successfully.

After finishing the setting, you can also push "Read" button to read its current network address.

Note:

1. The whole network system can connect 32 SL485 serial port expansion boards as most.
2. Setting address via software will be valid when all DIP are in the OFF state;
3. It's band rate is 9600.