

# WINIX ZERO 4 AIR PURIFIER



## USER MANUAL

SAVE THESE INSTRUCTIONS FOR FUTURE REFERENCE

# CONTENTS

CONTENTS.....	2
4-STAGE AIR PURIFICATION .....	3
CONTROLS.....	4
WHERE TO USE .....	5
INSTALLING FILTERS .....	6
SAFETY AND CAUTIONS.....	8
INITIAL OPERATION.....	9
AUTO & SLEEP .....	10
MANUAL & TIMER .....	11
PLASMAWAVE® & AIR QUALITY INDICATOR .....	12
FILTER CARE .....	13
PARTICLE SENSOR CARE .....	17
CLEANING CARE .....	18
FREQUENTLY ASKED QUESTIONS .....	19
SAFETY INSTRUCTIONS.....	20
PRODUCT WARRANTY .....	21

# 4-STAGE AIR PURIFICATION

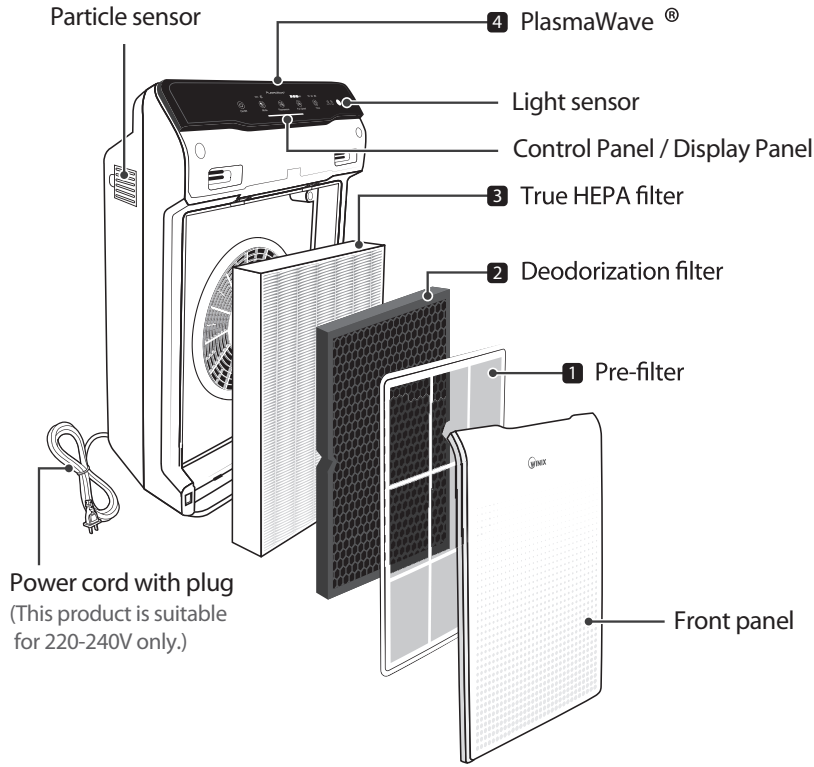

PACKAGE CONTENTS

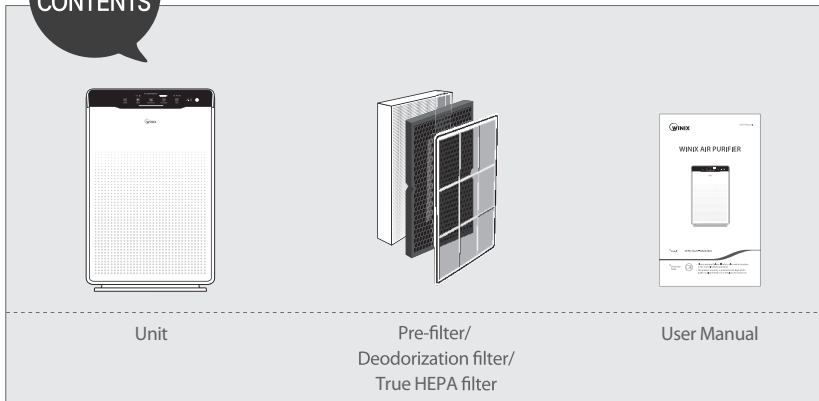

# CONTROLS

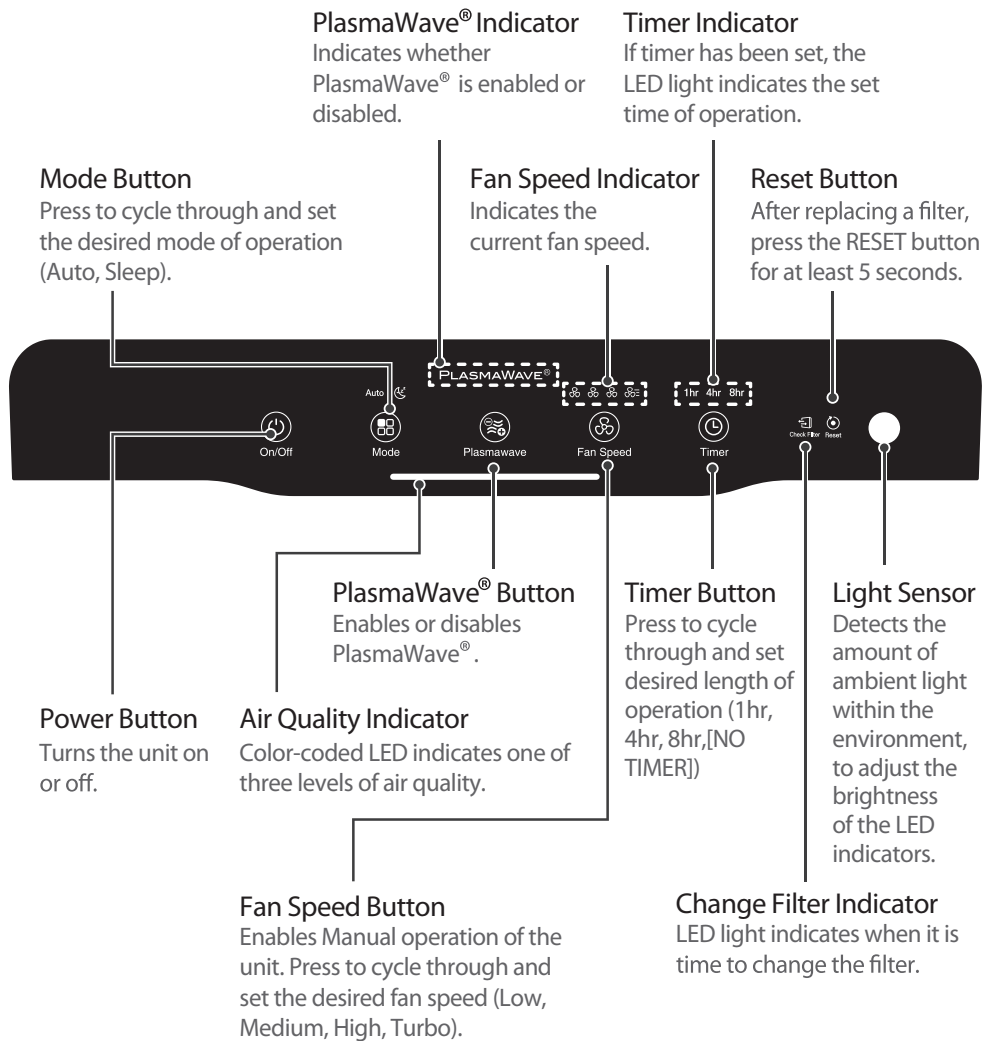
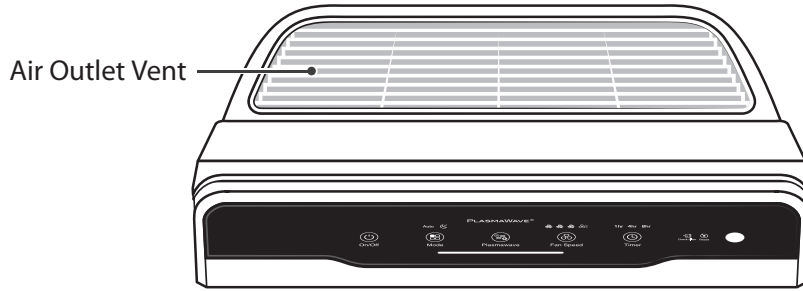

# WHERE TO USE

Allow 30 - 45cm of space between TVs, radios, and other electronic products electromagnetic interference from certain electronics may cause product malfunction.

Place indoors away from direct sun light direct exposure may cause product malfunction or failure.

Only place on hard, flat surfaces flimsy or slanted surfaces may result in abnormal noise and vibrations.

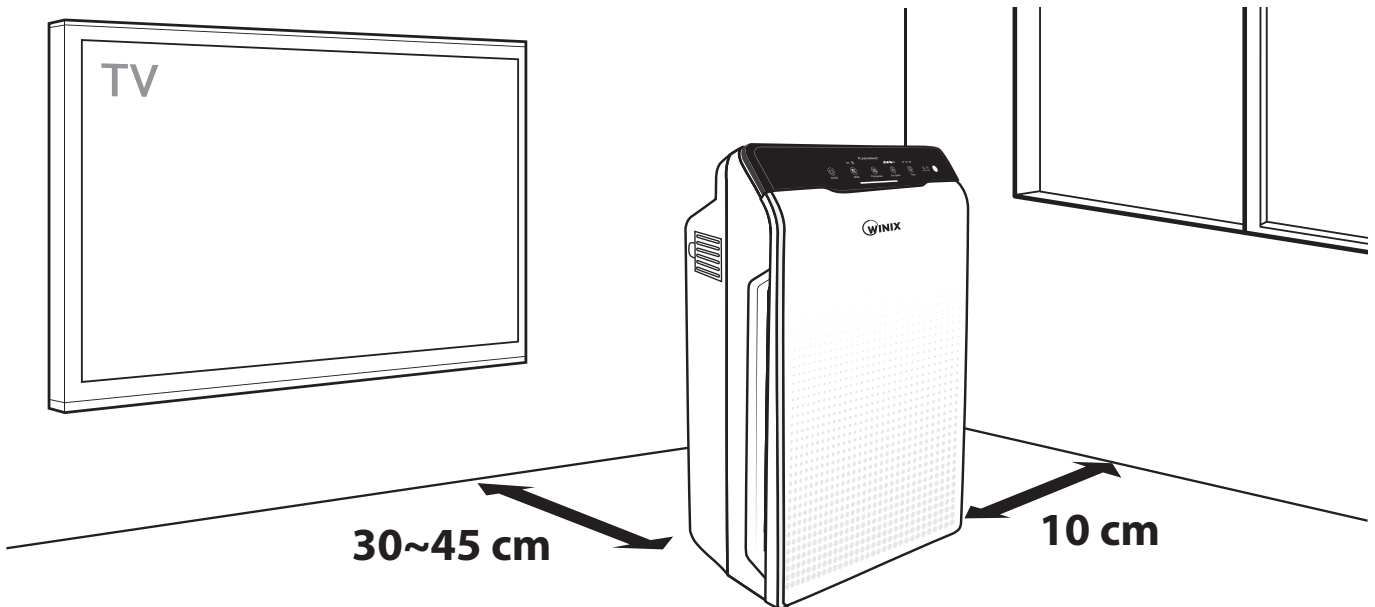

**⚠ WARNING**

Follow these instructions to reduce the risk of serious injury or death and to reduce risk of damaging the unit.

- ⚠ Do not use around mist or fumes from industrial oil or around large quantities of metallic dust.
- ⚠ Do not install in any sort of motor or transport vehicle (trucks, boats, ships, etc.).
- ⚠ Do not place near any flammable materials (aerosols, fuel, gases etc.).
- ⚠ Do not place below any electrical outlet.

- ⚠ Do not place around heating elements.
- ⚠ Do not place in an area with excessive amounts of noxious gases.
- ⚠ Do not have unit facing into wind or draft.
- ⚠ Do not place in excessively humid areas where unit may become wet.

# INSTALLING FILTERS

This product comes with all required filters. The protective plastic wrap must be removed from the filter before use.

- Operating the unit without removing the plastic wrap may result in product failure.
- Unplug and make sure the unit is turned off before installing filter.

1. Remove the front panel by grasping its upper edge and gently pulling forward.

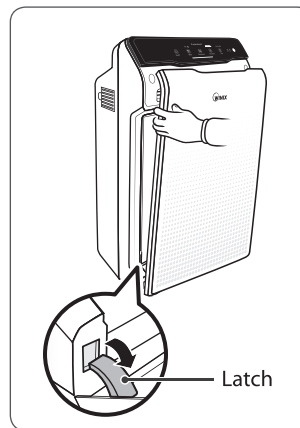

2. Remove the filters from the unit, they are protected inside a plastic wrap

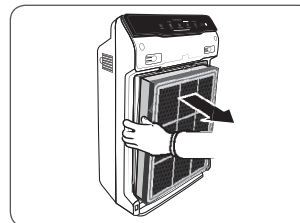

3. Remove filters from protective plastic wrap.
  - Operating the unit without removing filters from plastic wrap may cause abnormal noise, deformation, or fire as a result of overheating.

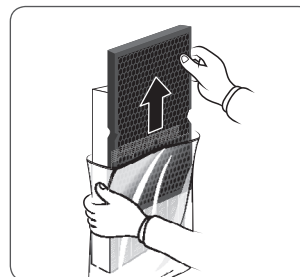

**NOTE :** Refer to pages 13 - 15 for details on how to replace filters.

To purchase replacement Winix filters :  
contact our authorized distributor  
'Ausclimate' or visit the below web site.

- TEL : 1800 122 100
- [www.ausclimate.com.au](http://www.ausclimate.com.au)
- [www.winixaustralia.com.au](http://www.winixaustralia.com.au)



4. Install the filters until they fit securely in place.

Filters must be installed in this order:

3 True HEPA Filter (rear)

2 Deodorization filter (middle)

1 Pre-filter (front)

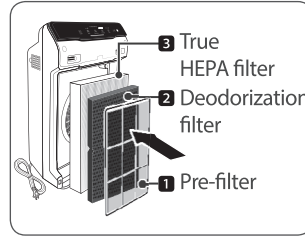

- To install the Pre-filter, insert bottom tabs into the slots on either side of the lower part of the unit, then rotate upward to insert the upper tabs into the slots at the top part of the unit until sides audibly click into place.

5. Replace the front panel by first inserting the latch at the bottom edge into the base of the unit, then rotate the panel upward toward the top of the unit until the magnets pull the lid closed.

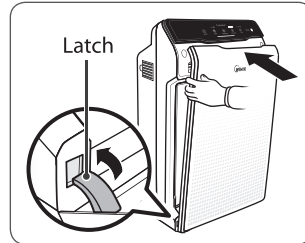

6. When to service and replace filter:

Filter	Indicator Light	When to service	When to replace
1 Pre-filter	none	Clean once every 14 days	Permanent
2 Deodorization filter	 Check Filter	Can NOT be WASHED	Lasts up to 12 months
3 True HEPA filter			

- Intervals between filter replacement may vary depending on environment.
- For optimal use, Pre-filter can be cleaned once every 14 days which can extend the life of other filters.

# SAFETY AND CAUTIONS

Before operating this equipment, carefully read and follow these safety cautions

**Ensure filters are inserted before running unit**

running unit without filters can shorten the units life and cause electric shock or injury.

**Be sure foreign objects are NOT inserted into the vents on the unit**

objects can include pins, rods, and coins.

**Do not touch any part of the interior of the unit with wet hands**

the high voltage may cause electric shock.

**Ensure unit intake and outlet vents do not become blocked**

blockage may lead to increased internal temperatures causing product failure and deformation.

**Do not use the unit as a step stool or place heavy objects on it**

personal injury may occur or product failure and deformation.

 **WARNING**

Follow these instructions to reduce the risk of serious injury or death and to reduce risk of damaging the unit.



Do not pull on the power cord when unplugging the unit



If the unit becomes submerged in water, unplug it and contact customer service



Do not plug additional appliances into the same outlet or power supply



Unplug unit when not in operation for extended periods of time



Do not tie or knot power cord when unit is in operation



Do not unplug or move the unit while in operation



Do not touch the plug with wet hands



Cord can become damaged by forcefully bending, pulling, twisting, bundling, pinching or placing heavy objects on it

- If the supply cord is damaged, it must be replaced by a special cord or assembly available from the manufacturer or its service agent.
- This appliance is not intended for use by a person (including children) with reduced physical sensory or mental capabilities, or lack of experience and knowledge, unless they have been given supervision or instruction concerning use of the appliance by a person responsible for their safety.
- Children should be supervised to ensure that they do not play with the appliance.



# INITIAL OPERATION

1. Insert the power cord into an electrical outlet.

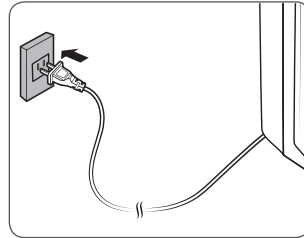

2. Press the 'Power' button.

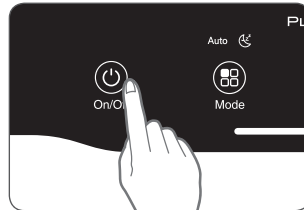

**NOTE :** During the first 30 seconds of power up, the Air Quality Indicator will cycle through Blue, Amber and Red colors. The Particle Sensors take approximately 30 seconds to gauge the air quality in the environment, after which normal operation will begin.

3. By default, when the unit first powers on, the mode will be set to Auto with PlasmaWave® enabled.

  - When in Auto mode, the fan speed will be automatically adjusted according to the environments air quality.
  - PlasmaWave® works to remove harmful airborne contaminants.



**NOTE :**

- In Auto mode, as the indoor air quality improves, the fan speed will automatically be reduced to Low.
- When the unit is running, you may hear a chirping or buzzing sound. The sound is from large particles passing through PlasmaWave®, it is normal and does not signify product failure. To disable PlasmaWave®, see page 12.

# AUTO & SLEEP

## Auto Mode

Enables auto operation based on the unit's air quality Particle Sensor.

1. Press the Mode button to select Auto mode.
  - The LED 'Auto' light will indicate when Auto mode is activated, and operation will begin.

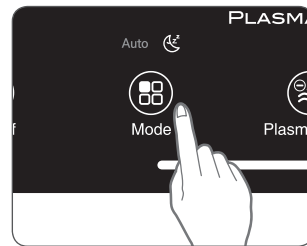

**NOTE :** When in Auto mode the fan speed is automatically adjusted according to the indoor air quality. As the indoor air quality improves, the fan speed will automatically be reduced. If the indoor air quality decreases, the fan speed will automatically increase.

## Sleep Mode

1. Press the Mode button to select Sleep mode.
  - The LED 'Sleep' light will indicate when Sleep mode is activated, and operation will begin.

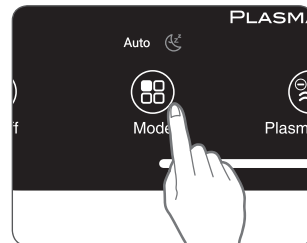

**NOTE :**

- When Sleep mode is selected, the fan speed is automatically set to Low. The fan speed can be manually changed by pressing the Fan Speed button, changing the unit into manual mode.
- When Sleep Mode is activated, the Air Quality Indicator LED light is disabled.

# MANUAL & TIMER

## Manual Mode (setting fan speed)

Users can opt to manually set the fan speed to Low, Medium, High, or Turbo.

1. Press the Fan Speed button to set the desired fan speed.

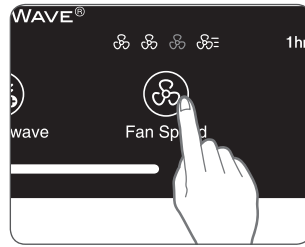

**NOTE :** When Manual Mode is selected, Auto Mode is automatically disabled.

## Timer

The timer can be set to let the unit run for a specified period of time.

1. Press the Timer button to select the desired length of time.
- When the Timer LED light will indicate the selected length of operation.
  - Every time the Timer button is pressed, The Timer LED light will cycle through the settings, (1hr, 4hr, 8hr, [NO TIMER]).

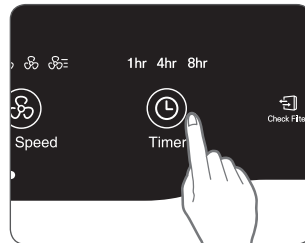

# PLASMAWAVE® & AIR QUALITY INDICATOR

## PlasmaWave®

By default, PlasmaWave® is enabled whenever the unit is powered on.

1. Press the Plasmawave button, when the unit is on, to enable or disable this feature.

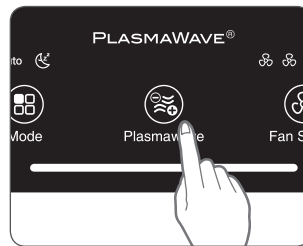

**NOTE :**

- In Auto mode, as the indoor air quality improves, the fan speed will automatically be reduced to Low.
- When the unit is running, you may hear a chirping or buzzing sound. The sound is from large particles passing through PlasmaWave®, it is normal and does not signify product failure.

## Air Quality Indicator

When on, the LED light will indicate the current indoor air quality according to three levels: BLUE (good), AMBER (fair), RED (poor).

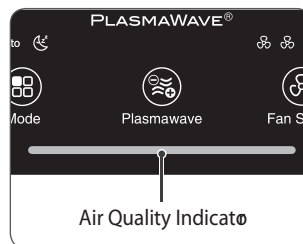

- NOTE :** Air quality level is displayed on the indicator, based on the Particle Sensors. Depending on the immediate environment, the indicator may change frequently in color or stay the same for lengthy periods of time.

# FILTER CARE

## Know The Filters

When the Check Filter indicator LED is on, it is time to replace both the True HEPA and Deodorization filters.

Filter	Indicator Light	When to service	When to replace
1 Pre-filter	none	Clean once every 14 days	Permanent
2 Deodorization filter	 Check Filter	Can NOT be WASHED	Lasts up to 12 months
3 True HEPA filter			

- Intervals between filter replacement may vary depending on environment.
- For optimal use, Pre-filter can be cleaned once every 14 days which can extend the life of other filters.

To purchase replacement Winix filters :  
contact our authorized distributor  
'Ausclimate' or visit the below web site.

- TEL : 1800 122 100
- [www.ausclimate.com.au](http://www.ausclimate.com.au)
- [www.winixaustralia.com.au](http://www.winixaustralia.com.au)

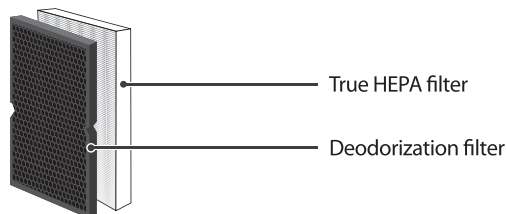

**NOTE :**

- The filters' life varies depending on the level of pollutants in the air. The more dust present in the environment, the more dust accumulates in the filters, shortening the life.
- If the filters are heavily soiled or have a bad odour, or if the fan strength is significantly weakened, replace filters even if the Change Filter indicator has not yet turned on.

## Removing Filters

Turn the unit power off before removing filters.

1. Remove the front panel by grasping its upper edge and gently pulling forward.

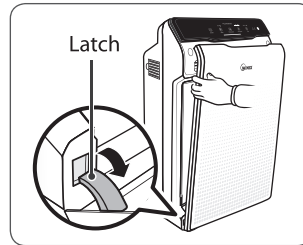

2. Press on the Pre-filter tabs near the top of the filter, release and remove.

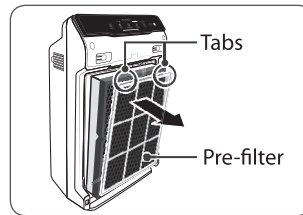

3. Pull out the Deodorization filter and True HEPA Filter.

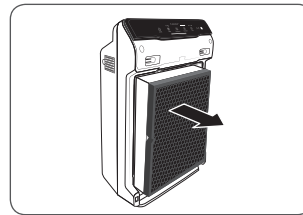

## Preparing New Filters

1. Remove replacement filters from protective plastic wrap.
- Operating the unit without removing filters from plastic wrap may cause abnormal noise, deformation, or fire as a result of overheating.

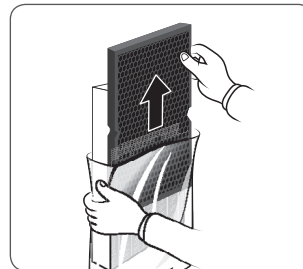

### NOTICE :

- For optimal performance, only Winix filters should be used with this unit.

## Replacing Filters

1. Insert the True HEPA Filter first, then the Deodorization filter.

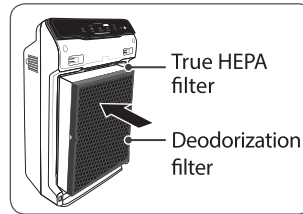

2. Insert the Pre-filter.
  - Insert bottom tabs of the Pre-filter into the slots on either side of the lower part of the unit, then rotate upward to insert the upper tabs into the slots at the top part of the unit until sides audibly click into place.

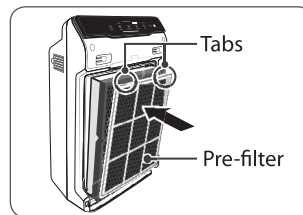

3. Replace the front panel by first inserting the latch at the bottom edge into the base of the unit, then rotate the panel upward toward the top of the unit until the magnets pull the lid closed.

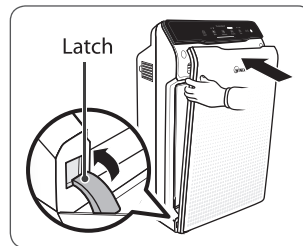

## Resetting The Unit

1. After replacing the filters, turn the power back on and then use a thin object, such as a paper clip, to press the RESET switch for 5 seconds.

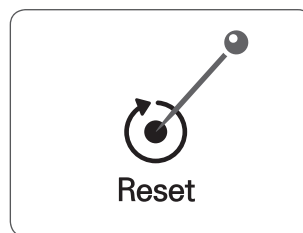

## Cleaning the filter

Intervals between filter cleaning may vary depending on the air quality.

1. Use a vacuum cleaner or soft brush to clean the Pre-filter. If it is excessively soiled, rinse in room temperature water.
  - Do not use detergent or soap.
  - Allow the filter to dry for 24 hours or more before using.

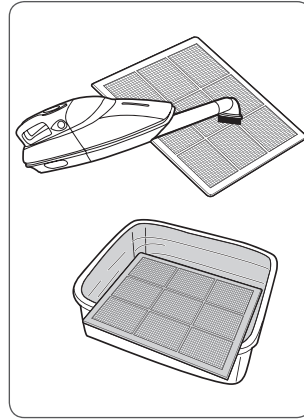

- If the pre-filter becomes damaged or in any way needs replacement: **Please contact your local dealer**

### NOTICE :

- Do not use benzene, alcohol, or other volatile fluids, which may cause damage or discoloration.
- The Pre-filter is reusable after cleaning, ensuring it is completely dry.
- Do not use hot water over 40°C or volatile fluids such as paint thinner.
- After washing the filter, allow it to dry completely in a well ventilated area. Otherwise, it may develop a bad odour.



# PARTICLE SENSOR CARE

## Particle Sensors Care

For optimal performance of the Particle Sensor, which detects airborne dust and ultrafine particles, clean it every two months. Clean it more frequently when the unit is running in a place with high dust levels.

1. Open the Particle Sensor cover.

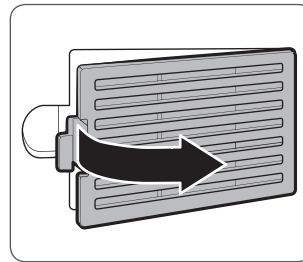

2. Use a damp cotton swab to wipe the lens and intake area of the Particle Sensor.

- To clean the sensor area, use only water. Do not use volatile substances such as alcohol or acetone

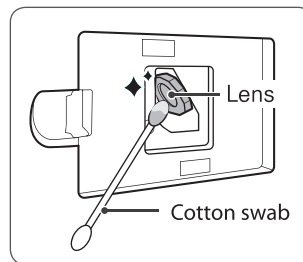

3. Wipe away any remaining moisture with a dry cotton swab.

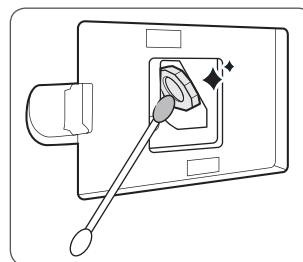

4. Close the Particle Sensor cover.

- The Particle Sensors cover may be cleaned using a vacuum cleaner

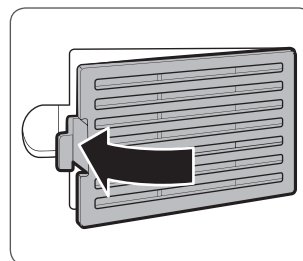

# CLEANING CARE

## Cleaning the Exterior & Interior

1. Wipe with a soft damp cloth using room temperature water. Afterwards, wipe it down with a clean dry cloth.

  - To keep unit in peak condition, clean every 1-2 months.

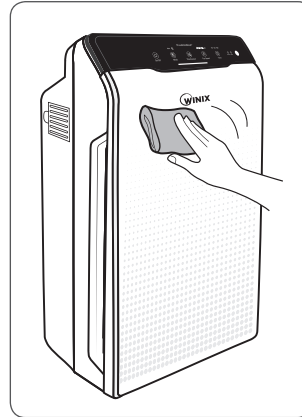

2. Open the front panel and clean the interior with a vacuum cleaner.

  - For optimal performance, clean every 1-2 months.

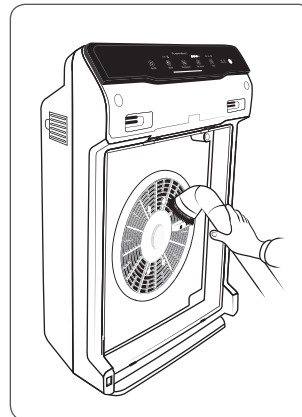

### NOTICE :

- When cleaning the unit, always unplug the power cord first and then wait until the unit has cooled down.
- Never disassemble, repair, or modify this unit yourself.
- Do not use flammable sprays or liquid detergents.
- Do not allow children to clean or maintain the unit.
- Before cleaning or maintaining, ensure unit is unplugged.

# FREQUENTLY ASKED QUESTIONS

Problem	Check / Actions to take
It does not turn on at all.	<ul style="list-style-type: none"> <li>Is the plug securely attached to the outlet?</li> <li>Make sure the outlet has power going to it, and ensure the plug is secured.</li> <li>Is there a power outage?</li> <li>Check to see if other lights and electrical equipment are working and try again.</li> </ul>
It doesn't work in Auto Mode.	<ul style="list-style-type: none"> <li>Has Auto Mode been selected?</li> <li>Press the Mode button until Auto Mode is selected.</li> <li>Is the sensor blocked or clogged?</li> <li>Wipe Odour Sensor with wet cloth, then dry.</li> </ul>
It vibrates and makes a lot of noise.	<ul style="list-style-type: none"> <li>Is it running on a slanted or uneven surface?</li> <li>Move the unit to a hard, flat, even area of the floor.</li> </ul>
The power plug and outlet feel hot.	<ul style="list-style-type: none"> <li>Is the plug securely plugged in?</li> <li>Make sure the plug is properly plugged into the outlet.</li> </ul>
There is a strange smell.	<ul style="list-style-type: none"> <li>Is it being used in a place with a lot of smoke, dust, or odours?</li> <li>Clean the air intakes on either side and clean the pre-filter.</li> <li>Clean or change the filter.</li> </ul>
The fan strength is weak. The unit is not purifying the air.	<ul style="list-style-type: none"> <li>Is the Check Filter indicator light on?</li> <li>Change the filters as required.</li> </ul>
The display panel is dim.	<ul style="list-style-type: none"> <li>Is the Light Sensor blocked by debris?</li> <li>When Auto Mode is on, Sleep Mode is automatically activated when the Light Sensor detects that the room is dark.</li> </ul>

## UNIT SPECIFICATIONS

Model Name	AUS-1050AZBU
Power Voltage	220 - 240 V, 50 / 60 Hz
Power Rate	35 W
Recommended room capacity	38.2 m <sup>2</sup>
Weight	7 kg
Dimensions	380 mm(W) x 208 mm(D) x 600 mm(H)
Replacement Filter	FILTER G1, item : 1712-0090-01
<ul style="list-style-type: none"> <li>The exterior, design, and product specifications may be changed without prior notice to improve product performance.</li> </ul>	

# SAFETY INSTRUCTIONS

Thank you for purchasing a Winix air purifier. This product is for household use only.

## IMPORTANT CAUTIONS FOR USING YOUR AIR PURIFIER

**WARNING :** Follow the instructions in this manual to reduce the risk of electric shock, short circuit, and/or fire.

- Do not repair or modify the unit unless specifically recommended in this manual. All other repairs should be completed by a qualified technician.
- Do not use if the power cord or plug is damaged or the connection to the wall outlet is loose.
- Use AC 220 - 240 V only.
- Do not damage, break, forcefully bend, pull, twist, bundle, coat, pinch, or place heavy objects on the power cord.
- Periodically remove dust from the power plug. This will reduce the risk of shock due to humidity build up.
- If the power plug is damaged, it must be replaced by the manufacturer or a qualified technician.
- Remove the power plug from the outlet before cleaning the unit. When removing the power plug, grasp by holding the plug itself, never hold by the cord.
- Remove the power plug from the outlet when not in use.
- Do not handle the power plug with wet hands.
- Do not operate the unit when using indoor smoke-generating insecticides.
- Do not clean unit with benzene or paint thinner. Do not spray insecticides on the unit.
- Do not use the unit where it is humid or where the unit may become wet, such as the bathroom.
- Do not insert fingers or foreign objects into air intake or outlet.
- Do not use the unit near flammable gases. Do not use near cigarettes, incense, or other spark-creating items.
- Unit will not remove carbon monoxide emitted from heating appliances or other sources.

## IMPORTANT PRECAUTIONS FOR USING YOUR AIR PURIFIER

- Do not block the intake or outlet vents.
- Do not use near hot objects, such as a stove.
- Do not use where the unit may come into contact with steam.
- Do not use the unit on its side.
- Keep away from products that generate oily residue, such as a deep fryer.
- Do not use detergent to clean the unit.
- Do not operate without a filter.
- Do not wash and reuse the True HEPA Filter or the Deodorization filter.
- Hold the handle on the back of the unit to transport.
- Do not hold by the front panel.

# PRODUCT WARRANTY

Product Name		Air Purifier
Model Name		AUS-1050AZBU
Purchase Date		
Warranty period		Two (2) years
Place of purchase		
Place of purchase Tel.		
Customer	Address	
	Name	
	Tel.	
<ul style="list-style-type: none"> <li>After purchase, be sure to complete all of the above information.</li> </ul>		

