



INDUSTRIAL DEHUMIDIFIER

MODEL: DDH 65L & 80L



INSTRUCTION MANUAL

SAVE THESE INSTRUCTIONS FOR FUTURE REFERENCE

GENERAL INFORMATION

PACKAGING

Please DO NOT dispose of any packaging until you have checked the appliance is operational.

After removing the packaging ensure the contents are intact and complete. In the unlikely event of missing parts; contact your retailer.

DO NOT leave children unattended with any of the packaging since it is a potential source of danger. Disposal of all packaging must be carried out responsibly & safely and in accordance you're your local authority regulations.

ALWAYS recycle the packaging material where possible.

When using any electrically powered product, basic safety precautions should always be followed.

PLEASE READ THE INSRUCTIONS CAREFULLY AND IN FULL BEFORE USING THE PRODUCT.

IMPORTANT INSTRUCTIONS

WARNING - to reduce the risk of fire, electrical shock or injury to persons property:

1. Always operate the product from a power source of the same voltage, frequency and rating as indicated on the product identification plate.
2. Close supervision is necessary when any product is used by or near children the elderly or the infirm. Do not allow children to use the appliance as a toy.
3. Do not operate any product with a damaged power cord or plug, after the product malfunctions, dropped or damaged in any way. Return the complete product to the place of purchase for inspection, repair or replacement.
4. To reduce the risk of electric shock, do not expose the unit or flexible cord to moisture of any kind.
5. Switch off and unplug from the power socket when not in use, before assembling or before cleaning.
6. Do not place objects on the product or allow objects to obstruct the inlet or outlet openings, or operate in close proximity to walls or curtains, etc.
7. The use of attachments or accessories not recommended or sold by the product distributor may cause injury to persons or damage to property.
8. This product is intended for normal light commercial use only.
9. Do not attempt to dismantle the appliance.
10. Do not operate the appliance on a metal surface.
11. Do not use the appliance in artificially hot or humid conditions or allow to be used in a hazardous environment.
12. Do not clean the appliance with organic solvent.
13. This appliance is not intended for use by persons (including children) with reduced physical, sensory or mental capabilities or lack of experience and knowledge unless they have been given supervision or instruction concerning use of the appliance by a person responsible for their safety.
14. Children should not be left unsupervised with the appliance.
15. This instruction manual is an integral part of the appliance and should be stored for safe keeping and must always accompany the appliance in the event of ownership transfer or for reference to by a service engineer.

READ AND SAVE THESE INSTRUCTIONS

PRODUCT IDENTIFICATION

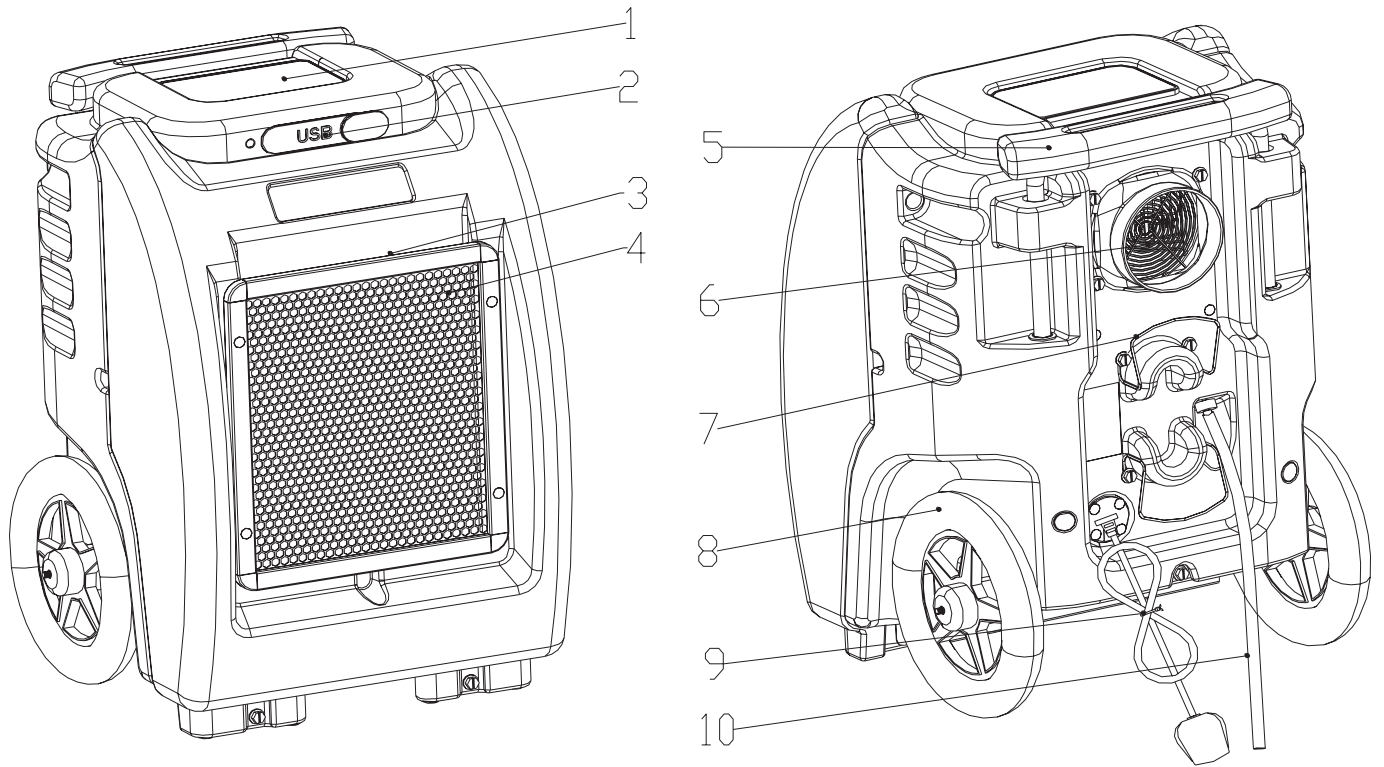

ITEM No.	DESCRIPTION
1	Control Panel
2	USB Data Interface
3	Air Filter
4	Air Inlet Grill
5	Handle
6	Air Outlet
7	Thread stand
8	Wheels
9	Power Cord
10	Drain Hose

SETTING UP INSTRUCTIONS

SETTING UP THE DEHUMIDIFIER: Operate the dehumidifier in an enclosed area, as this creates a drying chamber. Close all doors, windows or areas that open to external areas, to maximize the dehumidifier's water removal efficiency. Keep traffic through the drying chamber to a minimum. Place the dehumidifier in the centre of the room away from walls and furnishings.

DO NOT allow the airflows to be obstructed

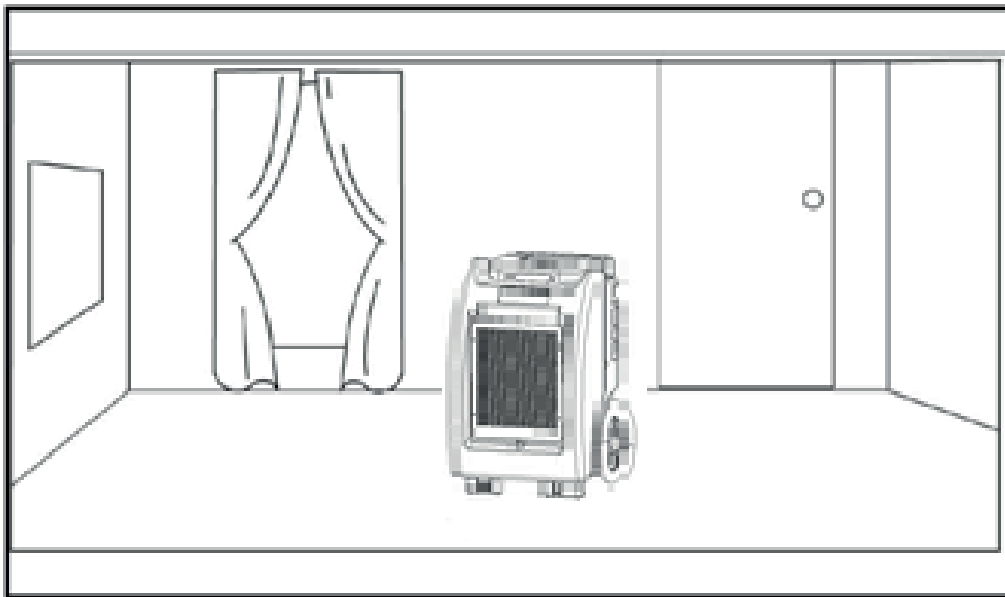

Illustration of correct positioning for best performance

DRAINAGE: The dehumidifier pump connects to a plastic drainage hose. The hose is stored on the back of the appliance. Uncoil the entire hose ensuring there are no kinks or restrictions and place the unattached end into a water vessel or run to outdoors.

Ensure that water which runs to outdoors does NOT create a slip hazard.

Water vessels MUST be checked regularly where used.















CONTROL PANEL



Hour counters

Two digital hour counters are built-into the control system.

Function Keys

-  ON/OFF: Press once to turn the unit ON or OFF.
-  PURGE: Press the PURGE key to empty water from the pump reservoir. During normal operation the pump purges automatically when the reservoir is full. Use 'PURGE' before moving the machine to avoid water spillage. The pump will close automatically after forty seconds continuous operation.
-  and 
 1. Press  and  key to set or adjust humidity in The range between 25% and 90%. When the environmental humidity is below 26% . The unit will power off.
 2.  and  key is used to adjust set time.
 3.  and  key used to switch menu functions.
-  Press the function key, the panel displays 'Humidity setting' 'Timer' 'Clock' 'Language' 'ID' 'USB/SD-CARD' 'GSM', Press  to select sub menu. Repress  key, the appliance will return to normal menu.
-  Press the ENTER key to confirm menu selection.

Note: References to Language`ID`USB/SD-CARD and GSM is optional functions. It's not necessary all function fit for you unit. If unit not include this functions . An error message will be displayed when use of these functions is attempted.

OPERATION (USING THE CONTROL PANEL)

Plug in electrical cord

The Aider 65L&80L dehumidifier should be plugged into a RCD¹-protected 230 volt outlet rated for at least 15A amps, the LCD display: “Standby Ran 00000H; Standby Last job 00:00; Standby time 00:00”, Three appear alternately, each 10s transforms one time.

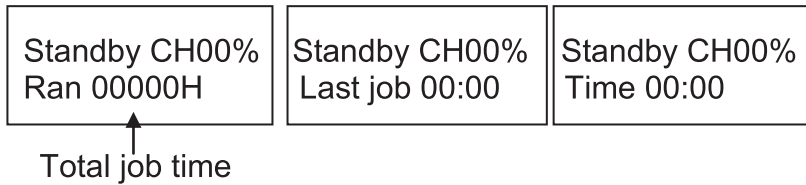

Turn the unit on

The control panel on the Capture 65L has a display and a touchpad with six keys. Press the **ON/OFF** to turn the unit on.

ON/OFF. Press the **ON/OFF** key to turn the unit on or off. When the machine turns on, the display normally reads “Dehumidifier on” and after three second, the display reads “HS 00% CH 00% Time 00:00”, “HS 00% CH 00% Job 00:00H” two appear alternately, each 10s transforms one time.

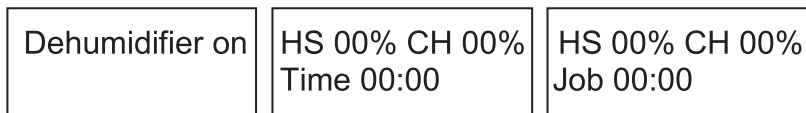

¹ Residual-Current Device

When the machine turn off, the display normally read “Dehumidifier off draining.....” The water pump will turn on automatically for 40 seconds to drain the residual condensate water in the dehumidifier.

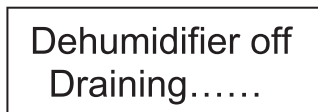

NOTE : DO NOT switch the power **OFF** by disconnecting at the mains socket outlet. To avoid water spillage; **DO NOT** move the Dehumidifier for at least three minutes after turning the power **OFF**.



Before transporting, be sure to remove the External drain hose, drain it carefully, and return it to the pocket provided on the back of unit.

Humidity setting



The factory setting is continuous. The humidity can be set in the following manner:

1. Press the  key. The screen will display: Humidity setting, Timer, Clock, Language, ID, USB/SD-CARD, and GSM.

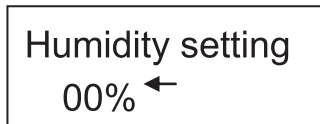

2. Press  and , select "Humidity setting" at one time.
3. Press "" and the screen will display:





4. Press "" or "" key, to select Relative Humidity between 25% and 90%
5. Press  key to select desired setting.







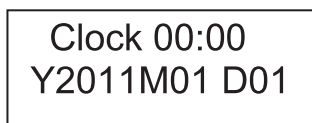

Clock

Press the  key. The screen will display: Humidity setting, Timer, Clock, Language, ID, USB/SD-CARD, GSM.



- 1.
2. Press the "" and "" key to select Clock at one time.
3. Press the  key & the screen will display:



4. Press "" or "" key to select hour from 00 to 23.
5. Press "" and "" key at one time, the cursor turns to the next position.
6. Press "" or "" key to select minutes from 0 to 59.
7. Press "" and "" key at one time, the cursor turns to the next position.
8. Use the same process to set "year" "month" "day", repeat process until the clock is completely set.
9. Once finished, press the  key to return to normal operating mode. The screen will display set time only.

In the event that data requires modifying; use the cursor to reset.

The new data will not become active until the  key is pressed.

Timer ON setting Ensure the clock is correct before setting the timer.

The factory setting is continuous. The humidity can be set in the following manner:

1. Press the key & the screen displays:

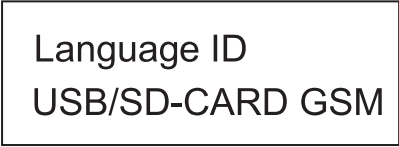
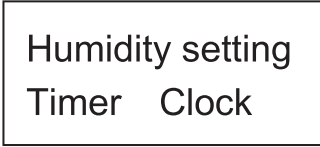

2. Press “” and “” key to select Time at one time.

3. Press key & the screen displays:

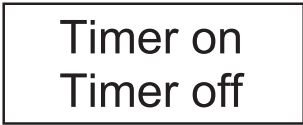

4. Press “” and “” key, select Timer on or Timer off.

5. Press the key & the screen will display:

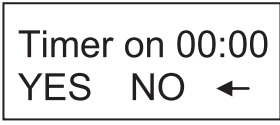

6. Press “” or “” keys to select from 00 to 23.
7. Press the “” and “” key at one time to select minute.
8. Press “” or “” key & select from 00 to 59.
9. Press the “” and “” key at one time to select YES or NO.
10. Press the key. The setting is completed.
11. Press the key. The display will return to normal.

To cancel the time display move the cursor to the ‘On’ position and press key, turning it to off. This function only performs once.

Timer OFF setting

Set the timer OFF in the same manner as timer ON

Cycle timer setting

The screen displays:

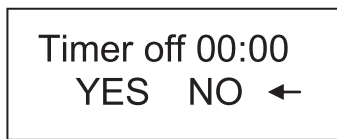

After setting the cycle timer the dehumidifier will turn **ON/OFF** at the selected times. The cycle is 24 hours.

Pressing 'On/Off' during the Cycle timer operation will not automatically cancel the program. The dehumidifier will not function if the Timer ON and Timer **OFF** times are the same.

To cancel the time display, press the **ENTER** key to change Timer **OFF** to Timer **ON**.

MAINTENANCE (CLEANING THE AIR FILTER)

Cleaning The Air Filter

Ensure the dehumidifier is turned OFF and the 13 Amp plug is removed from the power socket before maintenance is carried out. The working performance of the dehumidifier will be greatly reduced if the filters become blocked.

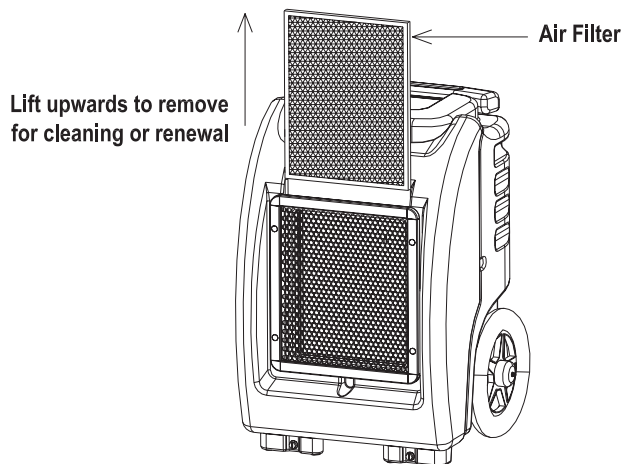

1. Remove the filter as shown in the diagram above.
2. Vacuum any debris from the filter using the vacuum hose and nozzle attachment.
3. Using luke-warm water and a mild detergent wash the filter and allow drying.
4. Once dry, re-install the filter into the dehumidifier

Replacing The Battery

1. Remove the screws in the four corners of the control panel.
2. Once the screws are removed, carefully lift the control panel to access the PCB.
3. On the PCB is a CR2032 battery. Remove the battery and replace with new.
4. Refit the control panel onto the PCB.
5. Refit the four screws.

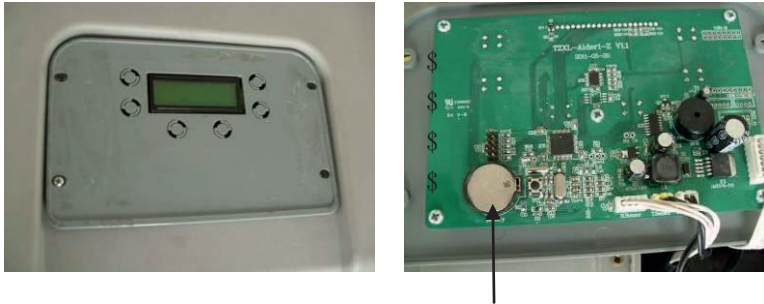

CR2032 battery

STORING THE MACHINE

Follow the guidelines below when storing the machine.

1. Wind the power cord to the back of the machine.
2. Wind the drainage tube to the back of the machine.
3. Stack the machines as shown if necessary. **NOTICE:** Do not stack more than two machines high.
4. Secure the machines as necessary to ensure they do not fall or move.

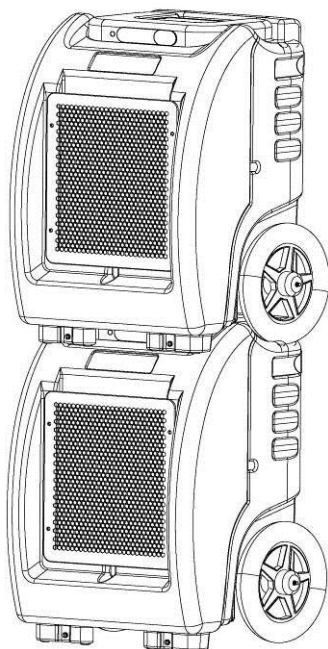

TROUBLE SHOOTING

FAULT	CAUSE	SOLUTION
Unit does not operate	No power to machine. Unit not switched on.	Plug in unit; check power at outlet and at base of unit. Switch unit on.
Blower wheel not turning	Obstructed blower.	Remove obstruction.
Unit operating, but room not dry	Not enough time to dry. Poor air movement in room. Excessive moist air infiltration.	Allow more time for drying. Increase air movement with air movers. Reduce infiltration.
Unit collects too little water	Room air is dry. Room temperature is too low.	Check humidity with hygrometer. Increase room temperature. Check filter and coils; clean as necessary.

WARNING:

DO NOT attempt to rectify faults using unqualified personnel. If the problem you are experiencing is not listed here, call your local distributor

Fault codes

The table below shows error message that the system may detect. If the display shows an “ER” message, first unplug the unit and then plug it back in. This may re-set the electronics, and if so, no further action is required. If the error message reappears, try the solution shown under “Explanation.” If this still does not fix the problem, contact your local authorized service center.

CODE	Error message	Display Reading	Reason
ER1	Coil sensor error	Flashes every 1 sec's	Timed defrost mode. The dehumidifier is working correctly.
ER2	Humidity sensor error	Flashes every 1 sec's	50% R.H displayed Continuous mode in operation
ER3	Low or no refrigerant	Flashes every 1 sec's	Turn power OFF. Then turn ON again.
ER4	Water pump fault or blockage	Flashes every 1 sec's	Dehumidifier will turn OFF automatically. The fault must be rectified before operation can commence.

If these solutions do not correct the error, contact your local distributor.

SPECIFICATION

Dehumidifying Capacity (30°C RH80%):	65L/day (137 pins/day)	80L/day (170 pins/day)
Dehumidifying Capacity (26.7°C RH60%):	38L/day (80 pins/day)	48L/day (100 pins/day)
Rating Power Input / Current (30°C RH80%):	980W/4.4A	1450W/6.4A
Rating Power Input / Current (26.7°C RH60%):	820W/3.7A	1150W/5.1A
Power Supply:	220-240V ~ 50Hz	220-240V ~ 50Hz
Refrigerant:	R410A/560g	R410A/720g
Working Temperature:	5°C~35°C	5°C~35°C
Controls	Electronic Touchpad	Electronic Touchpad
Process Air	520m ³ /H	520m ³ /H
Unit Size(mm):	540x540x810	540x540x810
Packing Size(mm):	580x580x850	580x580x850
Net/Gross Weight(kgs):	44kg/49kg	47kg/52kg

